



User Manual

W611W

Software Version: 2.12.4.8

Release Date: 2022/10/13

Directory

Directory	3
1 Picture	8
2 Table	13
3 Safety Instruction	14
3.1 Safety Instruction	14
3.2 Battery Warning	14
4 Overview	16
4.1 Overview	16
4.2 Packing Contents	17
5 Desktop Installation	18
5.1 Install the battery	18
5.2 Replacement battery	20
5.3 Connect the charging base	22
5.4 Install the belt clip	22
6 Appendix Table	23
6.1 Appendix I - Icon	23
6.2 Appendix II - Keyboard character query table	25
6.3 Appendix III - LED Definition	26
7 Introduction to the User	28
7.1 Instruction of Keypad	28
7.2 Using Handset / Hands-free Speaker / Headset	29
7.3 Power on/off operation	30
7.4 Connection Wi-Fi	30
7.5 Connect to Bluetooth	32
7.6 Sleep State	34
7.7 Standby Interface	34
7.8 Phone Status	35
7.9 Web Management	37
7.10 SIP Configurations	38
8 Basic Function	40
8.1 Making Phone Calls	40
8.2 Answering Calls	42
8.2.1 Talking	42

8.2.2 Make / Receive Second Call	43
8.3 End of the Call	44
8.4 Redial	44
8.5 Dial-up Query	45
8.6 Auto-Answering	45
8.7 Callback	47
8.8 Mute	48
8.8.1 Mute the Call	48
8.8.2 Ringing Mute	48
8.9 Call Hold/Resume	49
8.10 DND	50
8.11 Call Forward	52
8.12 Call Transfer	54
8.12.1 Blind transfer	54
8.12.2 Semi-Attended transfer	55
8.12.3 Attended transfer	55
8.13 Call Waiting	56
8.14 Conference	57
8.14.1 Local Conference	57
8.14.2 Network Conference	58
8.15 Anonymous Call	59
8.15.1 Anonymous Call	59
8.15.2 Ban Anonymous Call	61
8.16 Hotline	62
8.17 Emergency Call	62
9 Advance Function	64
9.1 Record	64
9.1.1 Server Record	64
9.1.2 SIP INFO Record	64
9.2 Agent	65
9.3 Intercom	66
9.4 MCAST	67
9.5 Message	69
9.5.1 SMS	69
9.5.2 MWI (Message Waiting Indicator)	69
9.6 SIP Hotspot	71
10 Phone Settings	74

10.1 Basic Settings	74
10.1.1 Language	74
10.1.2 Time & Date	74
10.1.3 Screen	76
10.1.3.1 Brightness and backlight	76
10.1.3.2 Screen Saver	77
10.1.4 Ring	77
10.1.5 Voice Volume	77
10.1.6 Greeting Words	78
10.1.7 Reboot	78
10.2 Phone Book	78
10.2.1 Local Contact	78
10.2.1.1 Add / Edit / Delete Contact	79
10.2.1.2 Add / Edit / Delete Group	80
10.2.1.3 Browse and Add / Remove Contacts in Group	80
10.2.2 Blocked List	81
10.2.3 Cloud Phone Book	82
10.2.3.1 Configure Cloud Phone book	82
10.2.3.2 Downloading Cloud Phone book	83
10.3 Call Log	84
10.4 Function Key	85
10.5 Wi-Fi	86
10.6 Headset	86
10.6.1 Wired Headset	86
10.6.2 Bluetooth Headset	87
10.7 Advanced	88
10.7.1 Line Configurations	88
10.7.2 Network Settings	88
10.7.2.1 Network Settings	88
10.7.2.2 VPN	91
10.7.2.3 Web Server Type	92
10.7.3 Set The Secret Key	92
10.7.4 Maintenance	95
10.7.5 Firmware Upgrade	97
10.7.6 Factory Reset	100
11 Web Configurations	101
11.1 Web Page Authentication	101

11.2 System >> Information	101
11.3 System >> Account	101
11.4 System >> Configurations	101
11.5 System >> Upgrade	102
11.6 System >> Auto Provision	102
11.7 System >> Tools	102
11.8 System >> Reboot Phone	102
12 Network >> Basic	103
12.1 Network >> Wi-Fi Settings	103
12.2 Network >> Service Port	104
12.3 Network >> VPN	104
12.4 Network >> Advanced	104
12.5 Line >> SIP	105
12.6 Line >> SIP Hotspot	110
12.7 Line >> Dial Plan	110
12.8 Line >> Action Plan	112
12.9 Line >> Basic Settings	114
12.10 Line >> RTCP-XR	114
12.11 Phone settings >> Features	115
12.12 Phone settings >> Media Settings	119
12.13 Phone settings >> MCAST	120
12.14 Phone settings >> Action	120
12.15 Phone settings >> Time/Date	120
12.16 Phone settings >> Time Plan	121
12.16.1 Repeat Period Select Daily	123
12.16.2 Repeat Period Select Weekly	124
12.16.3 Time Plan List	124
12.16.4 Delete	124
12.17 Phone settings >> Tone	125
12.18 Phone settings >> Advanced	125
12.19 Phonebook >> Contact	126
12.20 Phonebook >> Cloud phonebook	126
12.21 Phonebook >> Call List	127
12.22 Phonebook >> Web Dial	128
12.23 Phonebook >> Advanced	128
12.24 Call Log	128
12.25 Function Key >> Function Key	128

12.26 Function Key >> DSSKey Page	129
12.27 Function Key >> PTT	131
12.28 Function Key >> Softkey	132
12.29 Function Key >> Advanced	133
12.30 Application >> Manage Recording	133
12.31 Security >> Web Filter	133
12.32 Security >> Trust Certificates	134
12.33 Security >> Device Certificates	135
12.34 Security >> Firewall	136
12.35 Device Log >> Device Log	137
13 Trouble Shooting	138
13.1 Get Device System Information	138
13.2 Power on/off	138
13.3 Reboot Device	138
13.4 Reset Device to Factory Default	138
13.5 Screenshot	138
13.6 Network Packets Capture	139
13.7 Get Log Information	140
13.8 USB/U Disk Upgrade	140
13.8.1 USB Upgrade	140
13.8.2 U Disk Upgrade	141
13.9 Common Trouble Cases	142

1 Picture

Picture 1	- Install the battery	19
Picture 2	- Replacement battery	21
Picture 3	- Connect the charging base	22
Picture 4	- Install the belt clip	22
Picture 5	- W611W key layout	28
Picture 6	- Wi-Fi connection on the device side	31
Picture 7	- Popup without Wi-Fi connection	32
Picture 8	- Web connection Wi-Fi	32
Picture 9	- Connect to Bluetooth	33
Picture 10	- Sync mobile phone contacts	34
Picture 11	- Screen Layout / Default Main Interface	34
Picture 12	- Scroll Icon	35
Picture 13	- The Phone status	36
Picture 14	- WEB phone status	37
Picture 15	- Landing page	38
Picture 16	- Phone line SIP address and account information	38
Picture 17	- Web SIP registration	39
Picture 18	- Default line	40
Picture 19	- Enable voice channel dialing	41
Picture 20	- Open the voice channel and dial the number	41
Picture 21	- Call number	42
Picture 22	- Answering calls	42
Picture 23	- Talking interface	42
Picture 24	- The second call interface	43
Picture 25	- Two way calling	43
Picture 26	- Set redial DSS key	44
Picture 27	- Redial set	45
Picture 28	- Line 1 enables auto-answering	46
Picture 29	- The line has enabled auto-answering	46
Picture 30	- Web page to start auto-answering	47
Picture 31	- Set the callback key on the phone	47
Picture 32	- Set the callback key on the web page	48
Picture 33	- Mute the call	48
Picture 34	- Ringing mute	49
Picture 35	- Call hold interface	50

Picture 36	- Enable DND	50
Picture 37	- DND setting interface	50
Picture 38	- DND timer	51
Picture 39	- DND Settings	51
Picture 40	- Line DND	52
Picture 41	- Select the line to set up call forwarding	53
Picture 42	- Select call forward type	53
Picture 43	- Enable call forwarding and configure the call forwarding number	53
Picture 44	- Set call forward	54
Picture 45	- Transfer interface	55
Picture 46	- Semi-Attended transfer	55
Picture 47	- Attended transfer	56
Picture 48	- Call waiting setting	56
Picture 49	- Web call waiting setting	56
Picture 50	- Web call waiting tone setting	57
Picture 51	- Local conference setting	57
Picture 52	- <i>Local conference (1)</i>	58
Picture 53	- <i>Local conference (2)</i>	58
Picture 54	- Network conference	59
Picture 55	- Enable anonymous call	60
Picture 56	- Enable Anonymous web page call	60
Picture 57	- Anonymous call log	60
Picture 58	- Anonymous calls are not allowed on the phone	61
Picture 59	- Page Settings blocking anonymous call	61
Picture 60	- Phone hotline setting interface	62
Picture 61	- Hotline set up on webpage	62
Picture 62	- Set up an emergency call number	63
Picture 63	- Dial the emergency number	63
Picture 64	- Web server recording	64
Picture 65	- Web SIP info recording	65
Picture 66	- Configure the agent account in normal mode	65
Picture 67	- Configure the proxy account-hotel Guest mode	65
Picture 68	- Agent logon page	66
Picture 69	- Web Intercom configure	67
Picture 70	- Multicast Settings Page	68
Picture 71	- SMS icon	69
Picture 72	- New Voice Message Notification	70

Picture 73	- Voice message interface	70
Picture 74	- Configure voicemail number	71
Picture 75	- Register SIP account	71
Picture 76	- SIP hotspot server configuration	72
Picture 77	- SIP hotspot client configuration	73
Picture 78	- Phone language setting	74
Picture 79	- Language setting on Web page	74
Picture 80	- Set time & date on phone	75
Picture 81	- Set time & date on webpage	75
Picture 82	- Set screen parameters on phone	76
Picture 83	- Page screen Settings	77
Picture 84	- Phone screen saver	77
Picture 85	- Phone book screen	79
Picture 86	- Local Phone book	79
Picture 87	- Add New Contact	80
Picture 88	- Group List	80
Picture 89	- Browsing Contacts in a Group	81
Picture 90	- Add Contacts in a Group	81
Picture 91	- Add Blocked List	82
Picture 92	- Web Blocked List	82
Picture 93	- Cloud phone book list	83
Picture 94	- Downloading Cloud Phone book	83
Picture 95	- Browse contacts in cloud phone book	83
Picture 96	- Call Log	84
Picture 97	- Filter call record types	85
Picture 98	- DSS LCD key Page Configuration Screen	85
Picture 99	- DSS settings	86
Picture 100	- Headset function settings	87
Picture 101	- Bluetooth Settings Screen	87
Picture 102	- SIP address and account information	88
Picture 103	- Configure Advanced Line Options	88
Picture 104	- Network mode Settings	89
Picture 105	- DHCP network mode	89
Picture 106	- PPPoE network mode	90
Picture 107	- Static IP network mode	90
Picture 108	- IPv6 Static IP network mode	91
Picture 109	- The phone configures the web server type	92

Picture 110	- Menu password	93
Picture 111	- Set menu password	93
Picture 112	- Keyboard lock password	93
Picture 113	- Set keyboard lock password	94
Picture 114	- Phone keypad lock password input interface	94
Picture 115	- Web keyboard lock password settings	94
Picture 116	- Page auto provision Settings	95
Picture 117	- Phone auto provision settings	95
Picture 118	- Web page firmware upgrade	98
Picture 119	- Firmware upgrade information display	98
<i>Picture 120</i>	<i>- Network Priority</i>	<i>103</i>
<i>Picture 121</i>	<i>- WiFi Settings</i>	<i>103</i>
Picture 122	- Service Port Settings	104
Picture 123	- Dial plan settings	110
Picture 124	- Custom setting of dial - up rules	111
Picture 125	- Dial rules table (1)	112
Picture 126	- Dial rules table (2)	112
Picture 127	- Action Plan	113
Picture 127	- Time Plan (1)	122
Picture 129	- Time Plan (2)	123
Picture 130	- Time Plan (3)	124
Picture 131	- Time Plan (4)	124
<i>Picture 132</i>	<i>- Time Plan (5)</i>	<i>124</i>
Picture 133	- Time Plan (6)	125
Picture 134	- Tone settings on the web	125
Picture 135	- Web cloud phone book Settings	127
Picture 136	- DSSkey Page settings	129
Picture 137	- The SoftKey is configured as a Dsskey Page	130
Picture 138	- The navigation key is configured as a Dsskey Page	130
<i>Picture 139</i>	<i>-The Dsskey Page on the lcd</i>	<i>130</i>
<i>Picture 140</i>	<i>-Web page PTT settings</i>	<i>131</i>
Picture 141	- Global Key Settings	133
Picture 142	- Web Filter settings	134
Picture 143	- Web Filter Table	134
Picture 144	- Certificate of settings	135
Picture 145	- Device certificate setting	135
Picture 146	- Network firewall Settings	136

Picture 147 - Firewall Input rule table	137
Picture 148 - Delete firewall rules	137
Picture 149 - Screenshot.....	139
Picture 150 - Web capture	140
Picture 151 - reparation required for the U disk upgrade	141

2 Table

Table 1	- Keypad Icons	23
Table 2	- Status Prompt and Notification Icons	23
Table 3	- Look-up Table of Characters	25
Table 4	- Status Indicator LED State	26
Table 5	- Instruction of Keypad of W611W	28
Table 6	- Talking mode	42
Table 7	- Agency mode	65
Table 8	- Intercom configure	67
Table 9	- MCAST Parameters on Web	68
Table 10	- SIP hotspot Parameters	71
Table 11	- Time Settings Parameters	75
Table 12	- Auto Provision	96
Table 13	- Firmware upgrade	98
Table 14	- Service port	104
Table 15	- Line configuration on the web page	105
Table 16	- Phone 7 dialing methods	110
Table 17	- Dial - up rule configuration table	111
Table 18	- Action Plan	113
Table 19	- Set the line global configuration on the web page	114
Table 20	- VQ RTCP-XR Settings	114
Table 21	- General function Settings	115
Table 22	- Voice settings	119
Table 23	- Multicast parameters	120
Table 24	- Time&Date settings	120
Table 25	- Time Plan	122
Table 26	- Function Key configuration	128
Table 27	- Softkey configuration	132
Table 28	- Network Firewall	136
Table 29	- Trouble Cases	142

3 Safety Instruction

3.1 Safety Instruction

Please read the following safety notices before installing or using this unit. They are crucial for the safe and reliable operation of the device.

- Please use the external power supply that is included in the package. Other power supply may cause damage to the phone and affect the behavior or induce noise.
- Before using the external power supply in the package, please check the home power voltage. Inaccurate power voltage may cause fire and damage.
- Please do not damage the power cord. If power cord or plug is impaired, do not use it because it may cause fire or electric shock.
- Do not drop, knock or shake the phone. Rough handling can break internal circuit boards.
- This phone is designed for indoor use. Do not install the device in places where there is direct sunlight. Also do not put the device on carpets or cushions. It may cause fire or breakdown.
- Avoid exposure the phone to high temperature or below 0°C or high humidity.
- Avoid wetting the unit with any liquid.
- Do not attempt to open it. Non-expert handling of the device could damage it. Consult your authorized dealer for help, or else it may cause fire, electric shock and breakdown.
- Do not use harsh chemicals, cleaning solvents, or strong detergents to clean it. Wipe it with a soft cloth that has been slightly dampened in a mild soap and water solution.
- When lightning, do not touch power plug, it may cause an electric shock.
- Do not install this phone in an ill-ventilated place. You are in a situation that could cause bodily injury. Before you work on any equipment, be aware of the hazards involved with electrical circuitry and be familiar with standard practices for preventing accidents.

3.2 Battery Warning

- To prevent the battery pack from leaking, overheating and catching fire. Please observe the following precautions:
- Soft aluminum packaging foil is easily damaged by sharp edged parts such as nickel sheets, pins and needles.
- Do not hit the battery pack with any sharp parts.
- Do not immerse the battery pack in water or seawater.
- Do not use and place the battery pack near heat sources such as fire or heaters.
- Do not reverse the positive and negative poles.
- Do not connect the battery pack to the power outlet.

- Do not throw the battery pack into fire or heat.
- Do not connect the positive and negative poles directly to metal objects such as wires, which may cause a short circuit of the battery pack.
- Do not transport and store batteries together with metal items such as necklaces and hairpins.
- Do not knock or throw the battery pack.
- Do not directly solder the battery pack or battery, and do not pierce the battery with nails or other sharp objects.
- Please use the charger configured at the time of purchase when charging.

4 Overview

4.1 Overview

W611W is a portable WiFi phone, specially designed for the wireless communication needs of mobile office; it has a business-like appearance, light and portable, suitable for one-hand holding, equipped with a belt clip, and can be used for mobile office anytime and anywhere; it has built-in dual-band 2.4G&5G Wi-Fi -Fi, supports the latest WiFi6 protocol, supports fast roaming, and is widely used in various wireless network environments; high-quality two-way hands-free calling, supports three-way local calls; Mi, suitable for small and medium-sized enterprises, shopping malls, residences, hotels, warehouses For mobile office application scenarios, it provides users with mobile communication services with an excellent protection level of IP67, effective waterproof and dustproof, and anti-drop height of 1.2 meters.

W611W is a cost-effective portable office device that provides convenient operation while achieving environmental protection for users. It will be an ideal choice for business users and home users who pursue high quality and high efficiency.

In order to help some users who are interested to read every detail of the product, this user manual is provided as a user's reference guide. Still, the document might not be up to date with the newly release software, so please kindly download updated user manual from Fanvil website , or contact with Fanvil support if you have any question using W611W.

4.2 Packing Contents

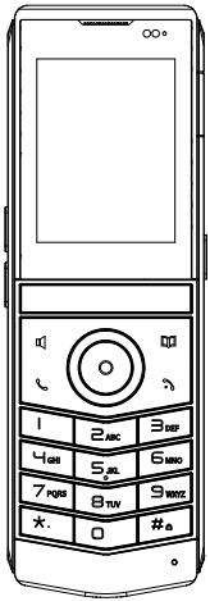

IP Phone



Battery Cover

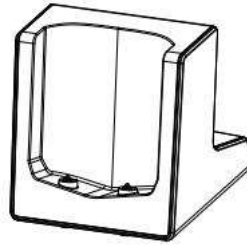

Charging Base

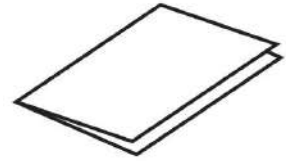

Quick Start Guide

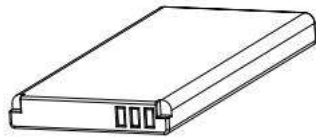

Rechargeable Battery

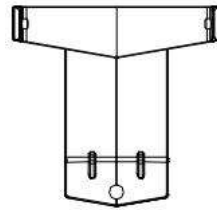

Belt Clip



Power Adapter

5 Desktop Installation

5.1 Install the battery

1. Removing the rear case: Remove the rear case of the whole machine with a little force from the handle position of the rear case of the main unit.

2. Install the battery: Take out the battery from the packaging box, with the battery with the notch facing up, put the battery C at the battery compartment C, and pull the battery button until it completely fits the underside of the battery.

3. Install the battery cover: Take out the battery cover from the packaging box, and press the battery cover firmly along the edge of the battery compartment to ensure that the outer surface of the battery cover is completely inserted into the battery compartment and flush with the edge of the battery compartment, reaching IP67 waterproof level.

4. Install the back cover: Align the back cover with the buckle on the back of the main unit, press your hands along the edge of the main unit from top to bottom (there will be a "click" sound during the process), and ensure that there is no gap, it means that the back cover is fastened.

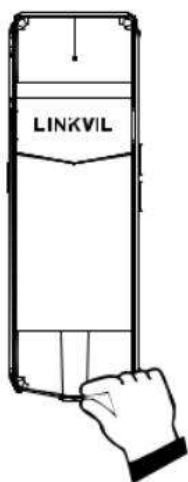

Removing the rear case

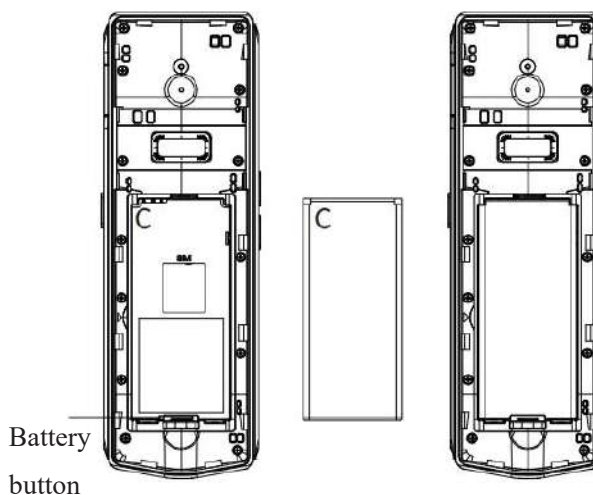

Install the battery

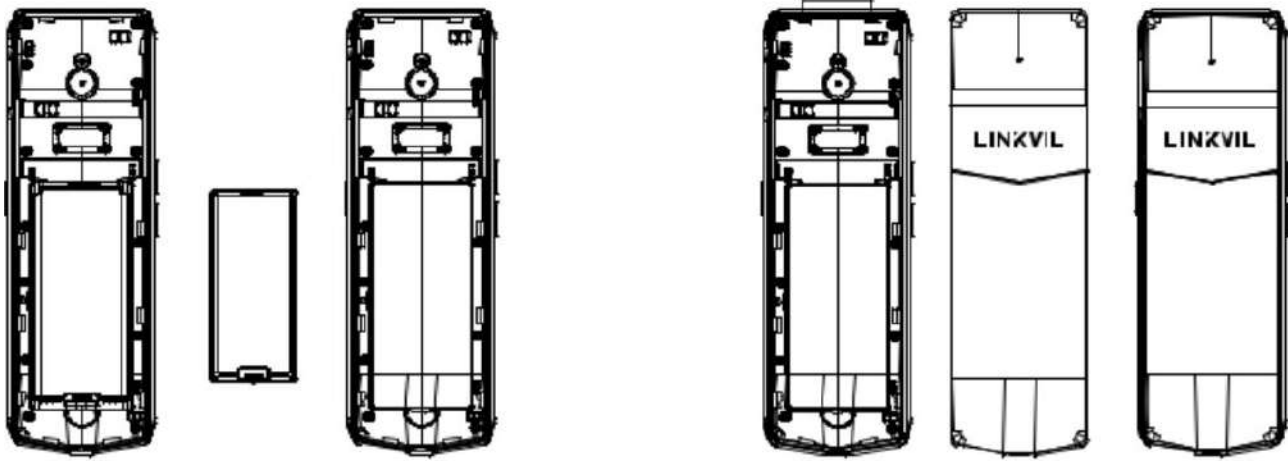

Install the battery cover

Install the back cover

Picture 1 - Install the battery

5.2 Replacement battery

1. Removing the rear case: Remove the rear case of the whole machine with A。 little force from the handle position of the rear case of the main unit.
2. Removing the battery cover :From the back of the main unit, buckle the hand position B, and pull it upwards in the direction indicated by the arrow at the same time (depending on the strength of different users, it may be removed after two or three times of pulling; in order to ensure the waterproof level of the machine , it is not easy to disassemble here).
3. Remove the battery: Pull the battery button down to remove the old battery.
4. Install the battery: Take out the battery from the packaging box, with the battery with the notch facing up, put the battery C at the battery compartment C, and pull the battery button until it completely fits the underside of the battery.
5. Install the battery cover: Take out the battery cover from the packaging box, and press the battery cover firmly along the edge of the battery compartment to ensure that the outer surface of the battery cover is completely inserted into the battery compartment and flush with the edge of the battery compartment, reaching IP67 waterproof level.
6. Install the back cover:Align the back cover with the buckle on the back of the main unit, press your hands along the edge of the main unit from top to bottom (there will be a "click" sound during the process), and ensure that there is no gap, it means that the back cover is fastened.

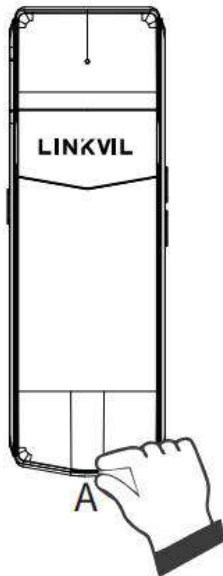

Removing the rear case
battery

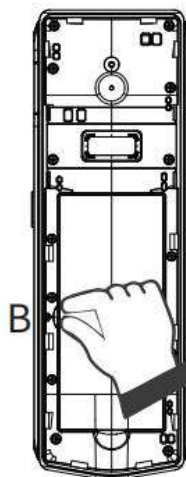

Removing the battery cover

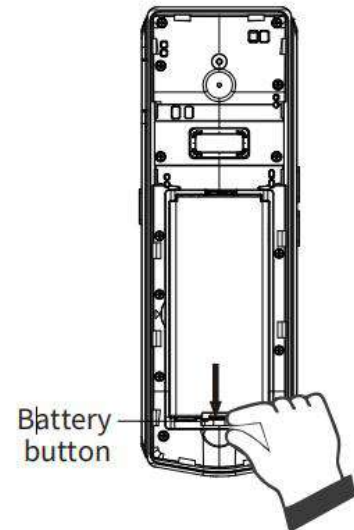

Remove the

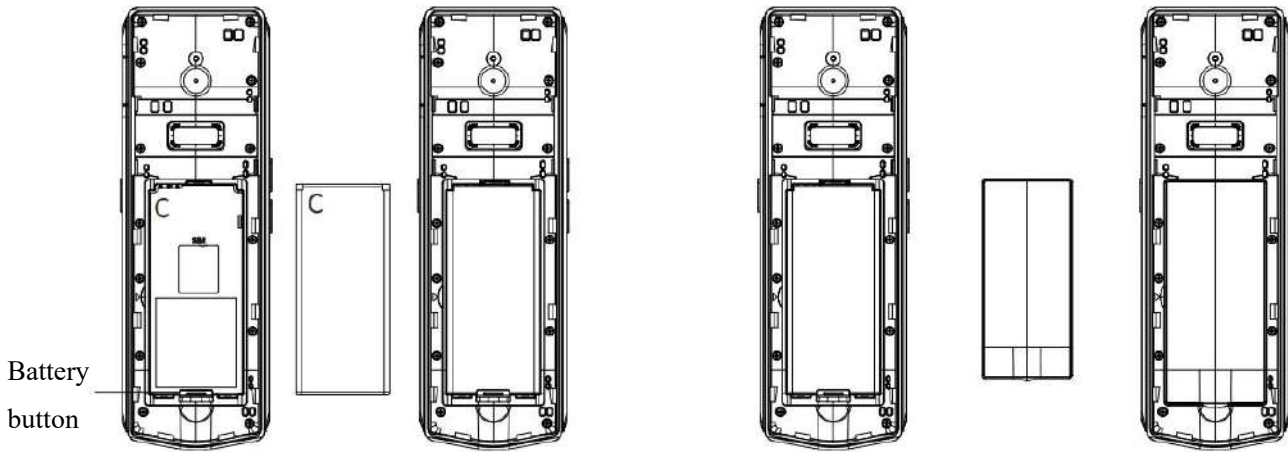

Install the battery

Install the battery cover

Buckle

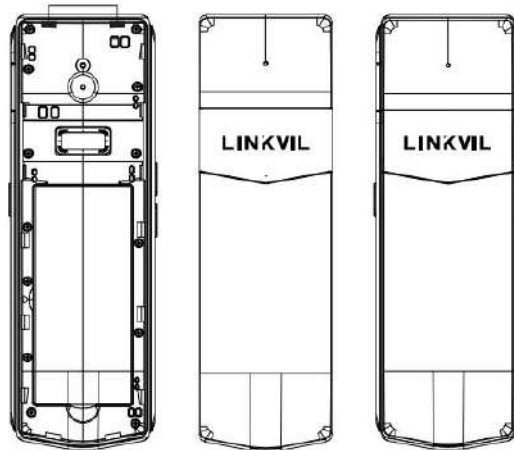

Install the back cover

Picture 2 - Replacement battery

Special statement: This product belongs to the three-proof equipment of IP67. Under normal use, please do not disassemble the battery cover arbitrarily. After long-term disassembly, the protection level of IP67 will be affected. We are not responsible.

5.3 Connect the charging base

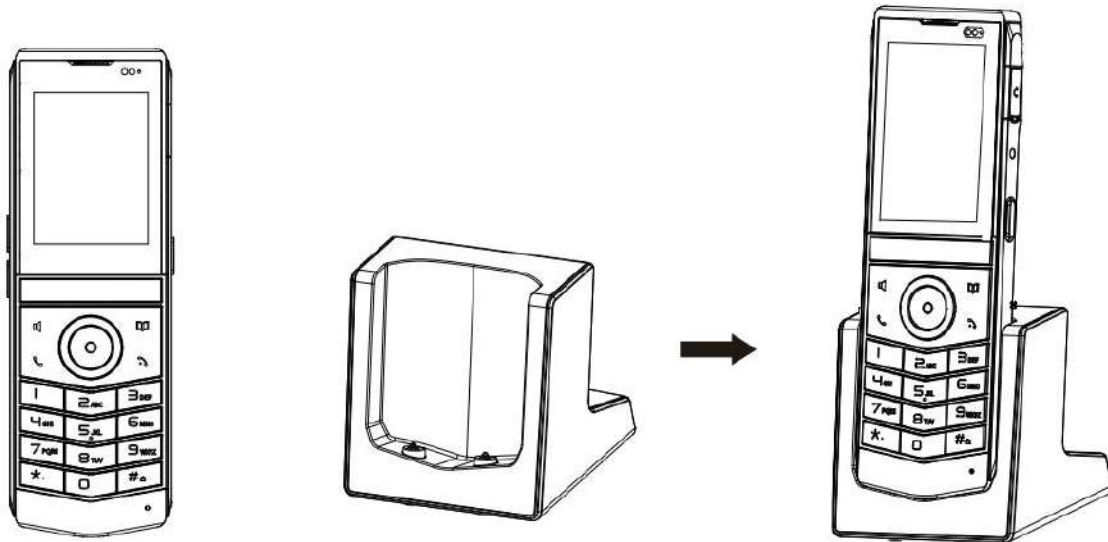

Picture 3 - Connect the charging base

Note:

1. Use Fanvil-supplied power adapter (5V/2A). A third-party power adapter may damage the handset.
2. Check the charging status on the top-right corner of the LCD screen.

5.4 Install the belt clip

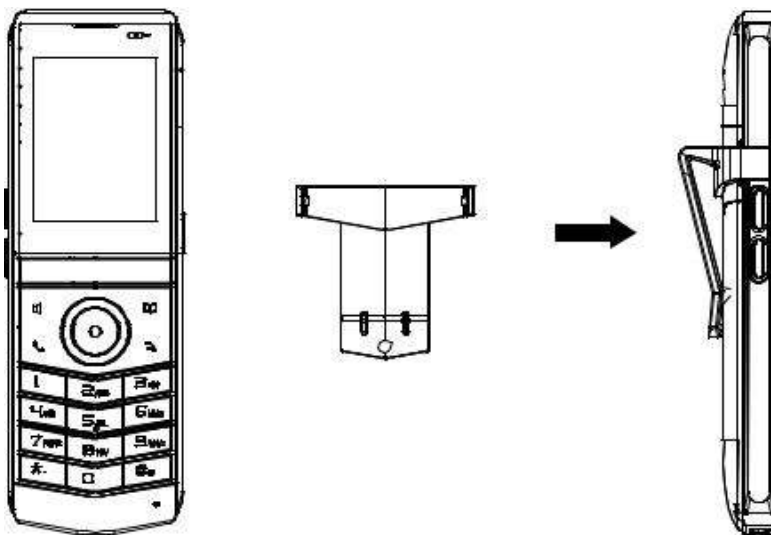

Picture 4 - Install the belt clip

6 Appendix Table

6.1 Appendix I - Icon

Table 1 - Keypad Icons

































Icon	Description
	Programmable keys, the default is PTT key, which can be set to function key/speed dial key, etc.
	Volume keys, in standby or ringing state: increase or decrease ringer volume During a call: increase or decrease the volume of the headset, handle, hands-free
	Softkey
	Left and right navigation keys Up key, call record shortcut key Down key, status shortcut key OK key
	Return to the home page; hang up the call; enter sleep state; exit sleep state Long press to power on/off
	Dial; switch the call channel
	Phone book keyboard
	Hands-free key, turn on/off the hands-free channel

Table 2 - Status Prompt and Notification Icons



Screen Icon	Description
	In hands-free mode
	In headset mode

	In handset mode
	Mute activated
	Silent mode
	Call is on hold
	Auto-answering activated
	Call forward activated
	Do not disturb activated (Red)
	SIP hotspot activated
	VPN activated
	Bluetooth device paired connection
	Voice quality level of call
	Keypad locked
	Forward call(s)
	Missed call(s)
	Received call(s)
	Dialed call(s)
	Internet connected
	Internet is disconnected

	No IP address
	Wireless network connected
	Wireless network disconnected
	Wireless network failure

6.2 Appendix II - Keyboard character query table

Table 3 - Look-up Table of Characters

Mode Icon	Text Mode	Key Button	Characters Of Each Press
	Numeric	1	1
		2	2
		3	3
		4	4
		5	5
		6	6
		7	7
		8	8
		9	9
		0	0
		*	*.:/@[],+ - _='?\'";()<>{}#
		#	Switch input method
	Lower Case Alphabets	1	@:;()<>[]{}
		2	a b c
		3	d e f
		4	g h i
		5	j k l
		6	m n o
		7	p q r s
		8	t u v
		9	w x y z
		0	(space)

		*	.,*/+:-_='?\" #^!&\$%		
		#	Switch input method		
ABC	Upper Case Alphabets	1	@:;()<>[]{}		
		2	A B C		
		3	D E F		
		4	G H I		
		5	J K L		
		6	M N O		
		7	P Q R S		
		8	T U V		
		9	W Z Y X		
		0	(space)		
		*	.,*/+:-_='?\" #^!&\$%		
		#	Switch input method		
		2aB	Mixed type input	1	1
				2	2 a b c A B C
3	3 d e f D E F				
4	4 g h I G H I				
5	5 j k I J K L				
6	6 m n o M N O				
7	7 p q r s P Q R S				
8	8 t u v T U V				
9	9 w z y x W Z Y X				
0	0				
*	.*/@[],+_-='?\" ;()<>{}# ^!&\$%				
#	Switch input method				

6.3 Appendix III - LED Definition

Table 4 - Status Indicator LED State

Type	LED Light	State
Status Indicator	Yellow On	Charging
	Green On	Fully Charged
	Red and Yellow Blinking alternately	Low Battery

Type	LED Light	State
	Yellow Breathing Blinking	Missed calls or unread messages
	Yellow Blinking Quickly	Ringing

7 Introduction to the User

7.1 Instruction of Keypad

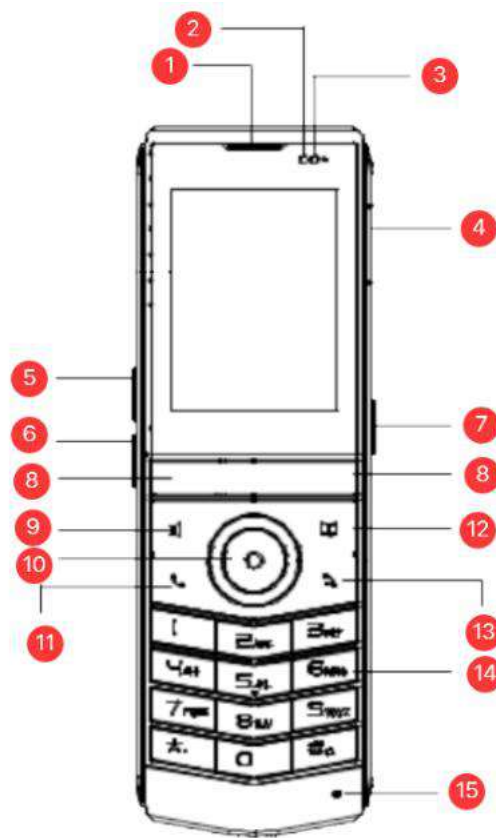

Picture 5 - W611W key layout

Table 5 - Instruction of Keypad of W611W

Number	The keypad names	Instruction
①	Earpiece	Play sound when talking in handset mode.
②	Light-sensing distance sensor	Cover this area during a call to adjust the brightness of the screen.
③	Status Indicator	Indicates the phone's in-call and charging status.
④	Earphone jack	Plug in headset, open headset channel.
⑤	Volume Up Key	In the standby state, ring and ring configuration interface, press this button to increase the ring volume; Press this button to increase the volume on the call or volume adjustment screen.
⑥	Volume Down Key	In the standby state, ring and ring configuration interface, press this button to reduce the ring volume; Press this button to lower the

		volume on the call or volume adjustment screen.
⑦	Function keys	Before configuration, short press/long press to enter the function key setting interface to configure the required function; after configuration, press to realize the corresponding function.
⑧	Function menu keys	These two buttons provide the menu functions displayed on the screen corresponding to them
⑨	Hands-free Key	The user can press this key to open the audio channel of the speakerphone.
⑩	Navigate/OK Keys	The user can press the up/down navigation key to change the line or move the cursor in the screen list. On some Settings and text editing pages, the user can press the left/right navigation key to change options or move the cursor in the screen list to the left/right. OK key: Default is equivalent to soft button confirmation, user can customize the function.
⑪	Dial key	Dial; switch the call channel
⑫	Phonebook key	Press the "Phonebook" button, the user can enter the phonebook interface, select a contact to call.
⑬	Hang up key	Return to the home page; hang up the call; Enter sleep state; exit sleep state Long press to power on/off
⑭	DTMF Key	These 12 standard phone keys provide standard phone button functionality. At the same time, certain long key presses can be triggered to provide special functions. #- Long Press the key to lock the phone (enable the keyboard lock configuration).
⑮	Microphone	Reception sound during a call.

7.2 Using Handset / Hands-free Speaker / Headset

■ Using Handset

To talk over handset, user should lift the handset off the device and dial the number, or dial the number first, then lift the handset and the number will be dialed. User can switch audio channel to handset by lifting the handset when audio channel is turned on in speaker or Headset.

■ Using Hands-free Speaker

To talk over hands-free speaker, user should press the hands-free button then dial the number, or dial the



number first then press the hands-free button. User can switch audio channel to the speaker from handset by pressing the hands-free button when audio channel is opened in handset.

■ Using Headset

In the factory settings, after inserting headset, the headset channel is turned on by default. When the headset is plugged in, the user can press the dial key to enter the number, and then press the dial key or "#" key; Or enter the number first and then press the dial key. The number will be dialed out and a call will be established through the headset channel. When the speaker is turned on, the user can switch the audio channel of the phone by pressing the dial key.

7.3 Power on/off operation

shutdown operation

- Hard shutdown: long press the red on-hook button  until shutdown.
- Soft shutdown: long press the red on-hook button  to pop up the shutdown window, choose whether to shutdown.
- Automatic shutdown when low battery: When the battery is about to run out, it will prompt "low battery". The phone automatically shuts down when the battery runs out.

reboot

- Go to Menu > Settings > Reboot System, and select Confirm Reboot.

boot operation

- Press and hold the red on-hook button until it turns on.

7.4 Connection Wi-Fi

Users can connect to Wi-Fi through the device or the web.

Device side

1. Enter [Menu] >> [Settings] >> [Wireless Network], and enable the wireless network.
2. Select an available network and click to enter.
3. Select the corresponding Wi-Fi network from the Wi-Fi list, click Connect, and enter the password.
4. After clicking OK, the Wi-Fi connection is successful, and the corresponding Wi-Fi display will show .

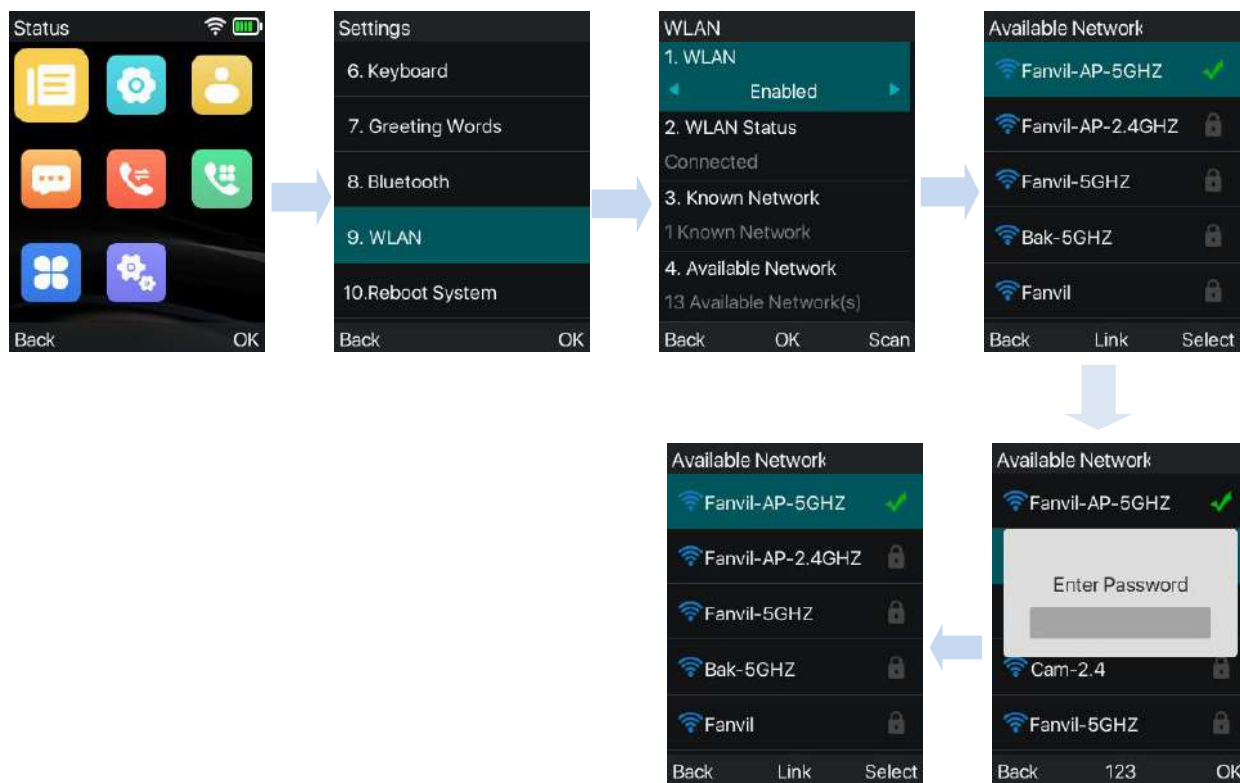

Picture 6 - Wi-Fi connection on the device side

Quick connection to the Wi-Fi

When the network is not connected, there are several situations:

- Wi-Fi Open Unconnected- -> Wi-Fi Off: prompt "Network Disconnect";
 - Cancel: Return to standby;
 - OK: Go to the Wi-Fi Settings;
- Wi-Fi open connected- -> Wi-Fi connection disconnected: prompt "IP acquisition failed";
 - Cancel: Return to standby;
 - OK: Go to the State-Network;
- Wi-Fi Open connected- -> Wi-Fi Off: two prompts, first "Network Disconnect" before "IP acquisition failure";
 - Cancel: Return to standby;
 - OK: Referto both above;

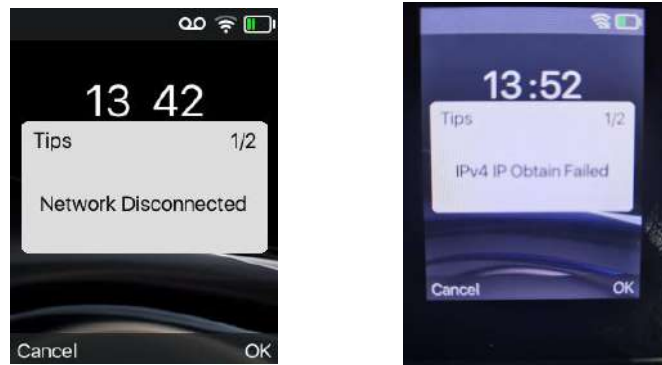

Picture 7 - Popup without Wi-Fi connection

web side

Log in to the device web page, and go to [Network] >> [Wi-Fi Settings]. Select to enable Wi-Fi, and configure the corresponding SSID, username and password.

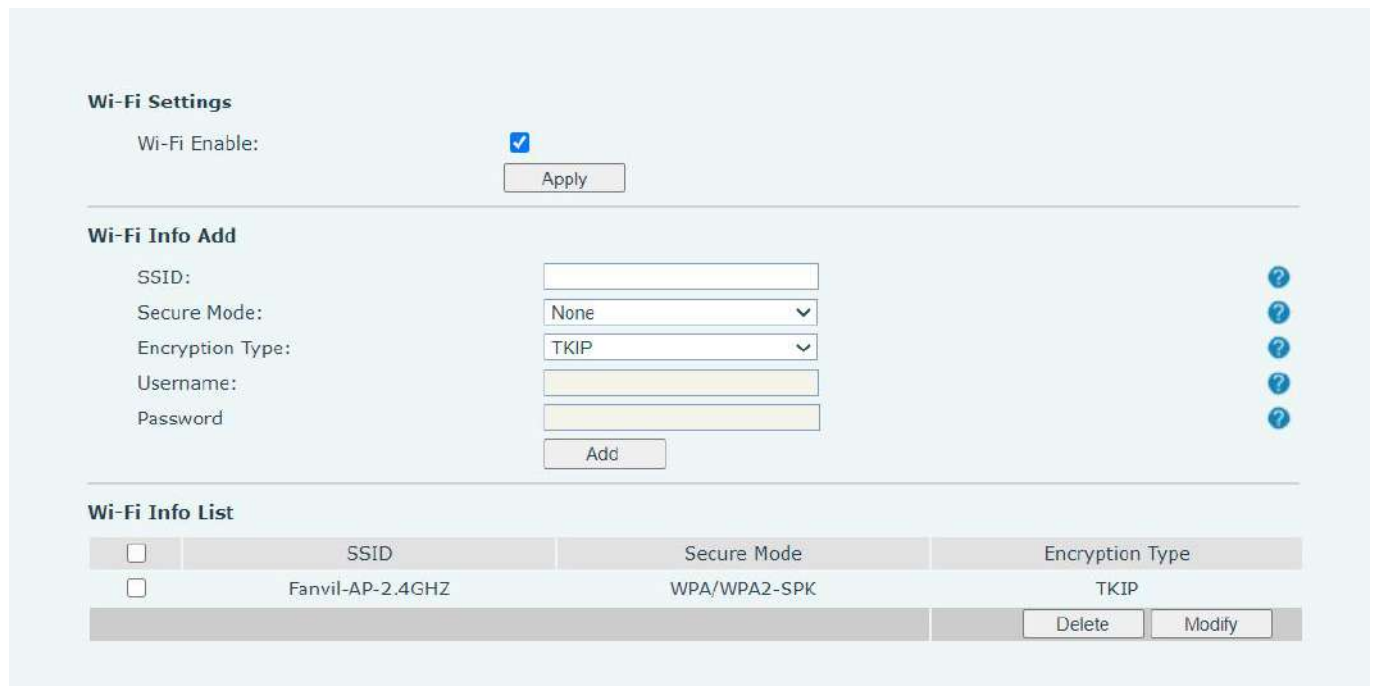

Picture 8 - Web connection Wi-Fi

7.5 Connect to Bluetooth

W611W supports Bluetooth external line.

The method of connecting W611W to a Bluetooth device is as follows:

1. Enter [Menu] >> [Settings] >> [Bluetooth Settings] to enable Bluetooth settings.
2. Select the paired device and press the OK button to scan for available Bluetooth around.
3. Select the corresponding bluetooth device in the bluetooth list, click connect, the screen will prompt the pairing key.

4. After the pairing confirmation is clicked on both the corresponding Bluetooth device and W611W, the Bluetooth connection is successful.
5. If the bluetooth device is a mobile phone, W611W will prompt **"Do you want to synchronize phone contacts?"** After confirming, the phone contacts will be synchronized to the W611W contact directory, which can be viewed in **[Menu] >> [Contacts] >> [Phone Book]**.
6. After the bluetooth is connected, the bluetooth icon  will be displayed after the bluetooth device in the bluetooth list. At the same time, the status bar of the standby interface will also display the Bluetooth icon.

Connect to Bluetooth

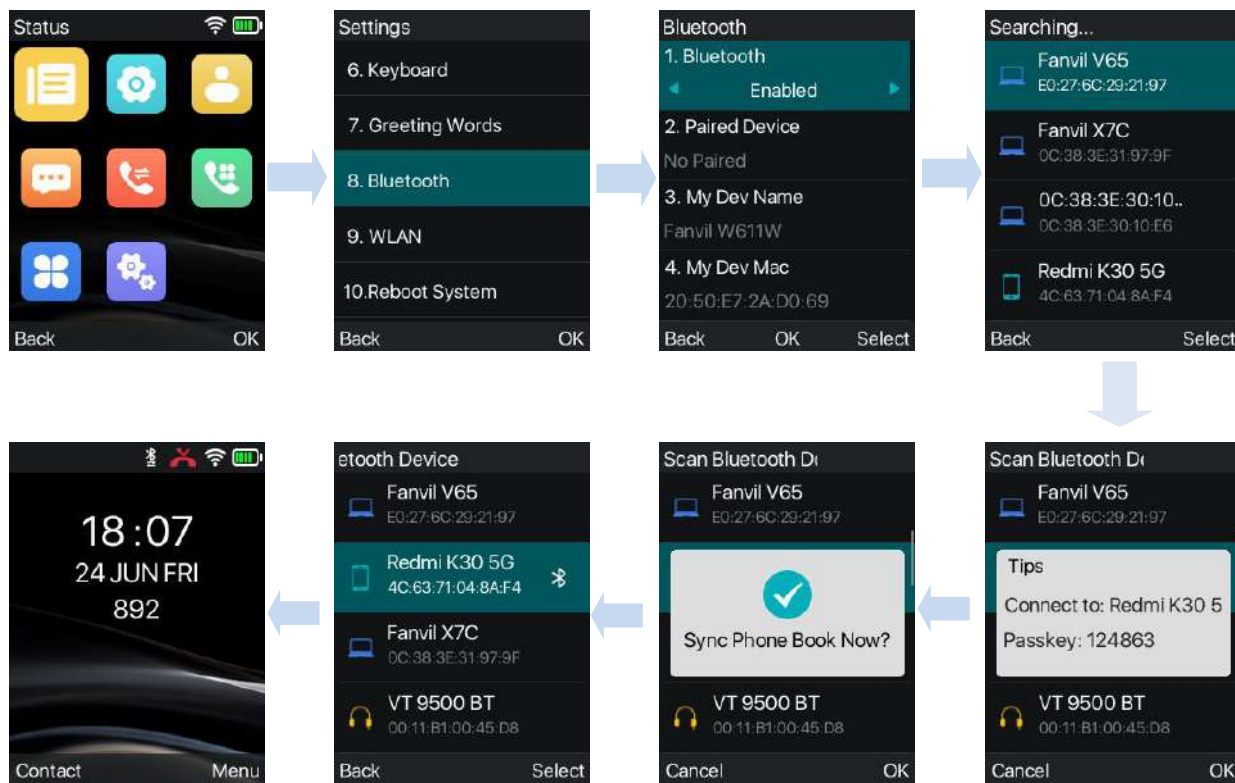

Picture 9 - Connect to Bluetooth

View Synced Mobile Contacts

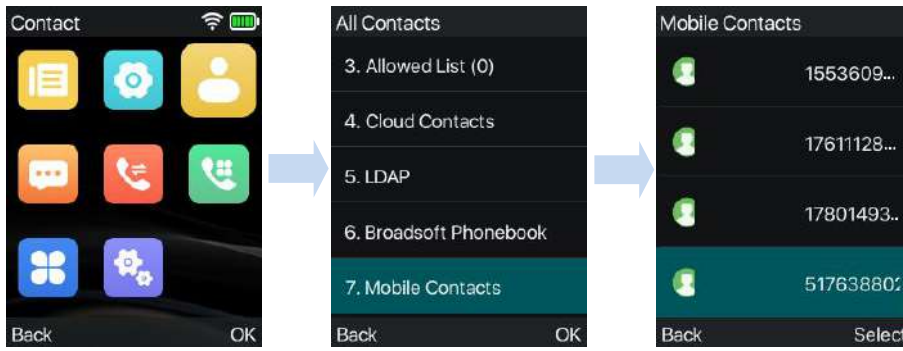

Picture 10 - Sync mobile phone contacts

7.6 Sleep State

enter hibernation

- When the W611W is in no operation state, it enters the sleep state by default for 15S.
- Standby press the red  hang up key to enter the sleep state.

exit hibernation

- The phone automatically exits the sleep state when there is an incoming call.
- Press the phone button to exit the sleep state.

7.7 Standby Interface



Picture 11 - Screen Layout / Default Main Interface

The image above shows the default idle screen interface, which is the state of the user interface most of the time.

The status bar on the main screen displays the device status, information and data that can be edited

(such as voice messages, missed calls, auto answer, do not disturb, locked status, network connection status, etc.).

The middle area shows the time and the registration status of the account.

The area below is the function menu buttons, which is also the first layer of the function menu buttons, through which the user can operate the phone.

The user can restore the phone to the default idle screen interface by pressing the on-hook key .

Icon description is described in [6.1 Appendix I](#).

On some screens, the screen does not fully display due to too many items or too long text. They will be grouped together into a list with scroll icons. If the user sees a scroll icon, they can use the up/down navigation keys to scroll through the list.

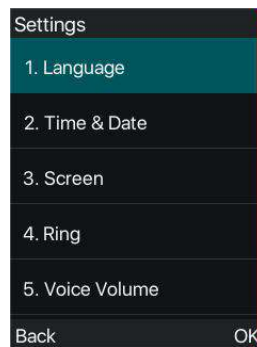

Picture 12 - Scroll Icon

7.8 Phone Status

The phone status includes the following information about the phone:

- Network Status:
 - IPv4 or IPv6 status
 - IP Address
 - Network mode
 - Wifi Name
- The Phone Device Information:
 - Ethernet MAC address
 - WiFi MAC address
 - Bluetooth MAC address
 - Phone Mode
 - Hardware Version number
 - Software Version number
 - Phone Storage (RAM and ROM)
 - System Running Time
- SIP Account Information:

SIP Account

SIP Account Status (register / uncommitted / trying / time out)

- TR069 Connect Status (Displays only in the phone interface state)

The user can view the phone status through the phone interface and the web interface.

- Phone interface: When the phone is in standby mode, press **【Menu】** >> **【Status】** and select the option to view the corresponding information, as shown in the figure:

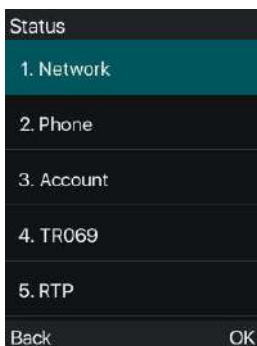

Picture 13 - The Phone status

- WEB interface: Refer to [7.9 Web management](#) to log in the phone page, enter the **【System】** >> **【Information】** page, and check the phone status, as shown in the figure:

System Information ⓘ

Model:	W611W
Hardware:	V1.0
Software:	T1.5.0
Uptime:	00 : 04 : 01
MEMInfo:	ROM: 24.6/128(M) RAM: 10.1/54(M)
System time:	09:19 27 JUN MON (SNTP)

Network ⓘ

WAN

Network mode:	DHCP
Ethernet MAC:	0c:38:3e:03:0b:3c
Wi-Fi MAC:	0c:38:3e:03:0b:3c
Bluetooth MAC:	20:50:e7:2a:d0:69

IPv4

Ethernet IP:	Disconnected
Wi-Fi IP:	172.16.0.207
Subnet mask:	
Default gateway:	172.16.2.1

VQ status ⓘ

Start time:	Stop time:
Local user:	Remote user:
Local IP:	Remote IP:
Local Port:	Remote port:
Local codec:	Remote codec:
Jitter:	JitterBufferMax:
Packets lost:	NetworkPacketLossRate:
MOS-LQ:	MOS-CQ:
RoundTripDelay:	EndSystemDelay:
SymmOneWayDelay:	JitterBufferRate:

SIP Accounts ⓘ

Line 1	892@172.16.1.2:5060	Registered
Line 2	N/A	Inactive
Line 3	N/A	Inactive
Line 4	N/A	Inactive

Picture 14 - WEB phone status

7.9 Web Management

Phone can be configured and managed on the web page of the phone. The user needs to enter the IP address of the phone in the browser and open the web page of the phone firstly. The user can check the IP address of the phone by pressing **[Menu]** >> **[Status]**.

Open the browser, enter the phone IP, log in to the phone web page, the first thing to see is the phone landing page.



Picture 15 - Landing page

Users must correctly enter the user name and password to log in to the web page. **The default user name and password are "admin"**. For the specific details of the operation page, please refer to page [11 Web configuration](#).

7.10 SIP Configurations

A line must be configured properly to be able to provide telephony service. The line configuration is like a virtualized SIM card on a mobile phone which stores the service provider and the account information used for registration and authentication. When the device is applied with the configuration, it will register the device to the service provider with the server’s address and user’s authentication as stored in the configurations.

The user can conduct line configuration on the interface of the phone or the webpage, and input the corresponding information at the registered address, registered user name, registered password and SIP user and registered port respectively, which are provided by the SIP server administrator.

- Phone interface: To manually configure a line, the user can press the button in the function menu **[Menu] >> [System] >> [Accounts] >> [Line n]** configuration, click ok to save the configuration.

NOTICE! User must enter correct PIN code to be able to System to edit line configuration. (The default PIN is 123)

The parameters and screens are listed in below pictures,.

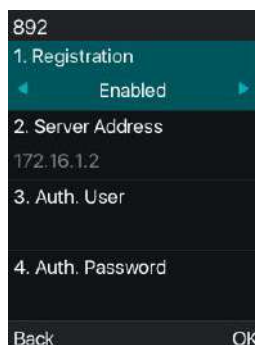

Picture 16 - Phone line SIP address and account information

- WEB interface: After logging into the phone page, enter **[Line] >> [SIP]** and select **SIP** for configuration,

click apply to complete registration after configuration, as shown below:

The screenshot displays the 'Web SIP registration' configuration page. On the left is a sidebar with a menu including System, Network, Line (highlighted), Phone settings, Phonebook, Call logs, Function Key, Application, Security, and Device Log. The main interface has a top navigation bar with tabs for SIP, SIP Hotspot, Dial Plan, Action Plan, Basic Settings, and RTPC-XR. Under the 'SIP' tab, there is a 'Line' dropdown menu showing '026@SIP1'. Below this is the 'Register Settings >>' section, which is divided into two columns for 'SIP Server 1' and 'SIP Server 2'. The 'SIP Server 1' configuration includes: Line Status: Registered; Username: 026; Display name: (empty); Realm: (empty); Server Address: 172.16.1.2; Server Port: 5060; Transport Protocol: UDP; Registration Expiration: 3600 second(s); Proxy Server Address: (empty); Proxy Server Port: 5080; Proxy User: (empty); Proxy Password: (empty). The 'SIP Server 2' configuration includes: Activate: checked; Authentication User: 026; Authentication Password: (masked with dots); Server Name: (empty); Server Address: (empty); Server Port: 5060; Transport Protocol: UDP; Registration Expiration: 3600 second(s); Backup Proxy Server Address: (empty); Backup Proxy Server Port: 5080. Each input field has a help icon (question mark) to its right.

Picture 17 - Web SIP registration

8 Basic Function

8.1 Making Phone Calls

■ Default Line

The phone provides multiple SIP line services. If both lines are configured, user can make or receive phone calls on either line. If default line is configured by user, there will be a default line to be used for making outgoing call which is indicated on the intermediate area. Enable or disable default line, user can press [Menu] >> [Features] >> [General] >> [Default Line] or configure from Web Interface ([Web] >> [PHONE] >> [Features] >> [Basic Settings]).

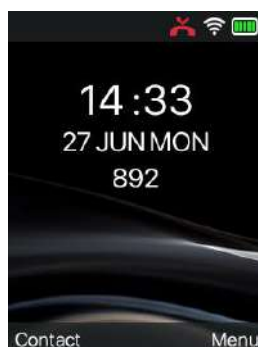

Picture 18 - Default line

■ Dialing Methods

User can dial a number by,

- Entering the number directly
- Selecting a phone number from phonebook contacts (Refer to [10.2.1 Local Contact](#))
- Selecting a phone number from cloud phonebook contacts (Refer to [10.2.3 Cloud Phone Book](#))
- Selecting a phone number from call logs (Refer to [10.3 Call Log](#))
- Redialing the last dialed number

■ Dialing Number then Opening Audio

To make a phone call, user can firstly dial a number by one of the above methods. When the dialed number is completed, user can press [Dial] button on the soft-menu, or press hand-free button, or user can press the dial key to call out with specified line.

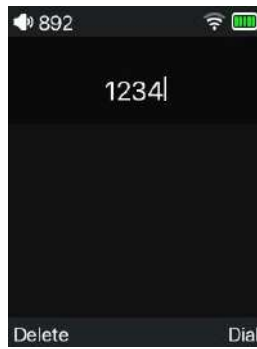

Picture 19 - Enable voice channel dialing

■ **Opening Audio then Dialing the Number**

Another alternative is the traditional way to firstly open the audio channel by lifting the handset, and then press the dial key  or handsfree key, dial the number with one of the above methods. When completing the number dial, user can press [**Dial**] button or [**OK**] button to call out, or the number can also be dialed out automatically after timeout.

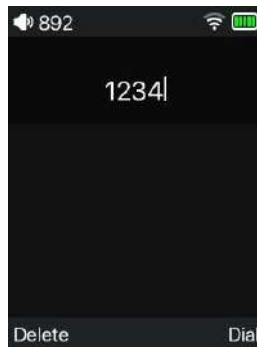

Picture 20 - Open the voice channel and dial the number

■ **Cancel Call**

While calling the number, user can stop the audio channel by putting back the handset or pressing the hands-free button to drop the call.

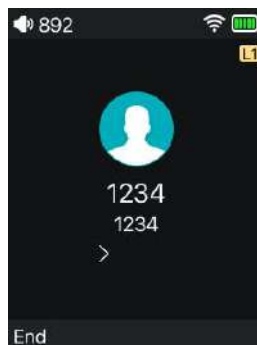



Picture 21 - Call number

8.2 Answering Calls

When there is an incoming call while the device is idle, user will see the following incoming call on the screen.



Picture 22 - Answering calls

User can answer the call by turning on the handset/headset/handsfree channel by pressing the dial key  or the handsfree key. To reject an incoming call, the user should press the hang up button .

8.2.1 Talking

When the call is connected, user will see a talking mode screen as the following figure.



Picture 23 - Talking interface

Table 6 - Talking mode

Number	Name	Description
①	Voice channel	The icon shows the voice channel mode being used.
②	Default line	The line currently used by the phone.
③	Call-to-end name	The name of the person on the other end of the call.
④	Call-to-end number	The number of the person on the other end of the call.
⑤	Call duration	The duration of a call after it has been established.

⑥	Speech quality	Displays the current voice quality of the call.
---	----------------	---

8.2.2 Make / Receive Second Call

The phone can support multiple calls. When there is already a call established, user can still answer another incoming call on either lines or make a second call on either lines.

■ Second Incoming Call

When there is another incoming call during talking a phone call, this call will be waiting for user to answer. User will see the call message in the middle of current screen. The device will not be ringing but playing call waiting tone in the audio channel of the current call and the LED will be flashing in orange. User can accept or reject the call as same as normal incoming call. When the waiting call is answered, the first call will be held on automatically.

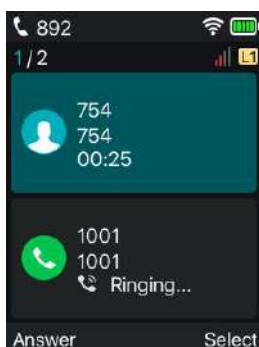

Picture 24 - The second call interface

■ Second Outgoing Call

To make a second call, User can press [Select] >> [New Call]/[Transfer]/[Conference] button to dial the second call. Then dial the number the same way as making a phone call. Another alternative for making second call is to press DSS Keys or dial out from the configured Keys (BLF/Speed Dial). When the user is making a second call with the above methods, the first call could be held on manually or will be held on automatically at second dial.

■ Switching between Two Calls

When there are two calls established, user will see a dual calls screen as the following picture.

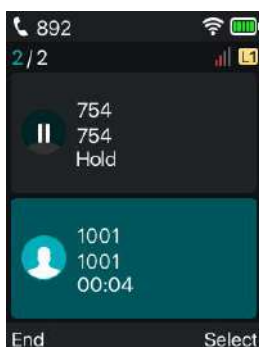

Picture 25 - Two way calling

User can press up/down navigator buttons to switch screen page, and switch call focus by pressing [Select] >> [Resume] button.

■ **Ending One Call**

User may hang up the current talking call by closing the audio channel or press [End] button. The device will return to single call mode in holding state. Users can also resume the current call by pressing the [Select] >> [Resume] key.

8.3 End of the Call

After the user finishes the call, the user can put the handle back on the phone, press the hands-free button or Softkey [End] key to close the voice channel and end the call.

Note! When the phone is in the reserved state, the user must press the [Resume] key to return to the call state, or put the receiver back and press the hands-free button to end the call.

8.4 Redial

W611W has no physical redial key, users can set the side function key as redial key when using. Setting method: In standby, press [Menu] >> [Settings] >> [Keyboard] >> [DSS Key Settings], select the function key to be set, select the type of function key for the type, and select Redial for the name of the function key. You can set the name of the callback key in the name input box, and press the [OK] button to save.

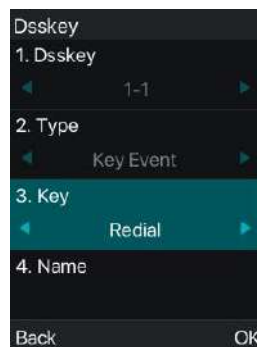

Picture 26 - Set redial DSS key

- Redial the last outgoing number:
When the phone is in standby mode, press the redial button and the phone will call out the last outgoing number.
- Call out any number with the redial key:
Enter the number, press the redial key, and the phone will call out the number on the dial.

- Press the redial key to enter the call record:

Log in the phone page, enter [Phone Settings] >> [Features] >> [Redial Settings], check Redial to enter the call record page, press the redial button when standby to enter the call record page, and press again to call out the current located number.

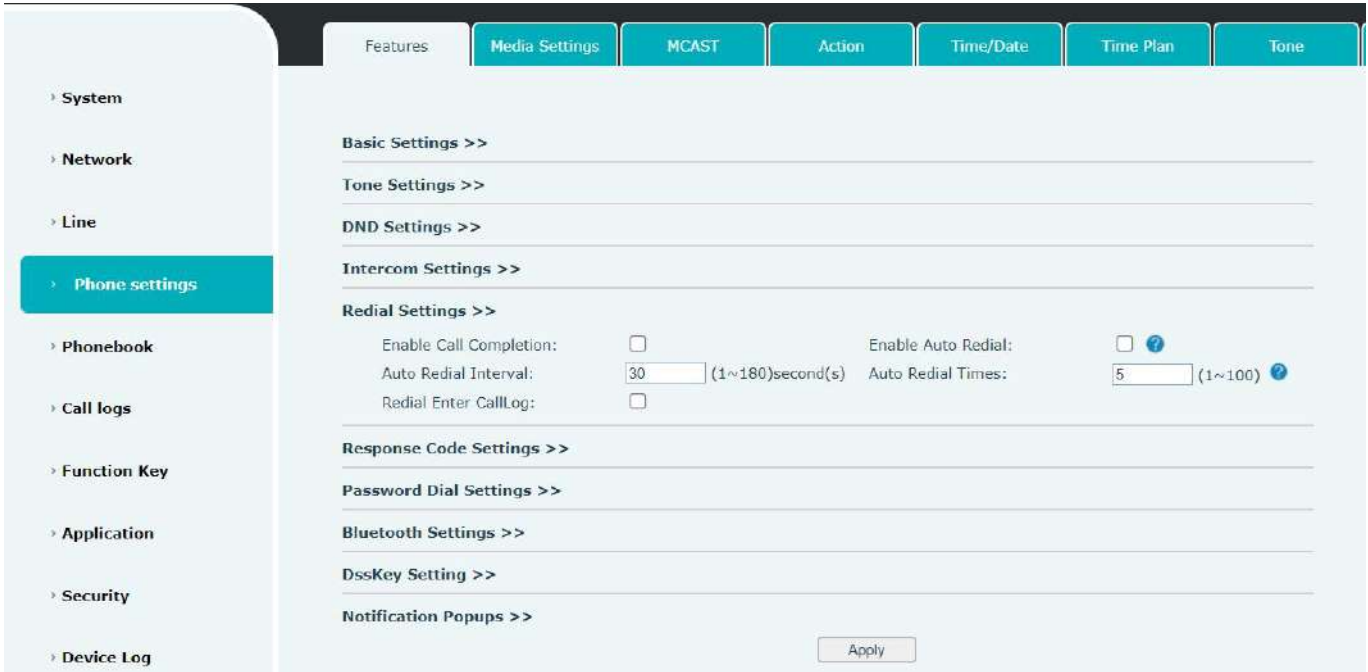

Picture 27 - Redial set

8.5 Dial-up Query

The phone is defaulted to turn on the dial-up inquiry function, dial-out, enter two or more numbers. The dial interface will automatically match the call records, contacts in the number list. Use the navigation key and up and down keys to select the number, press the call out key or wait for time out.

8.6 Auto-Answering

User may turn on the auto-answering mode on the device and any incoming call will be automatically answered. The auto-answering can be enabled on line basis.

The user can start the automatic answer function in the telephone interface or the webpage interface.

- **Phone interface:**

Press [Menu] >> [Features] >> [Auto Answer] button;

Press the button to select the line, use the left/right navigation key to turn on/off the auto answer option, and set the auto answer time to 5 seconds by default.

After completion, press [OK] key to save;

The icon in the upper right corner of the screen  indicates that auto answer is enabled.

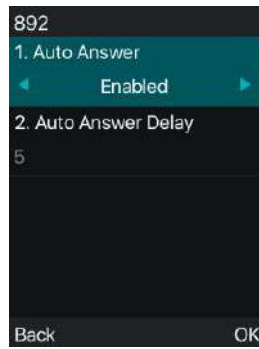

Picture 28 - Line 1 enables auto-answering



Picture 29 - The line has enabled auto-answering

- **WEB interface:**

Log in the phone page, enter [Line] >> [SIP], select [SIP] >> [Basic settings], start auto-answering, and click apply after setting the automatic answering time.

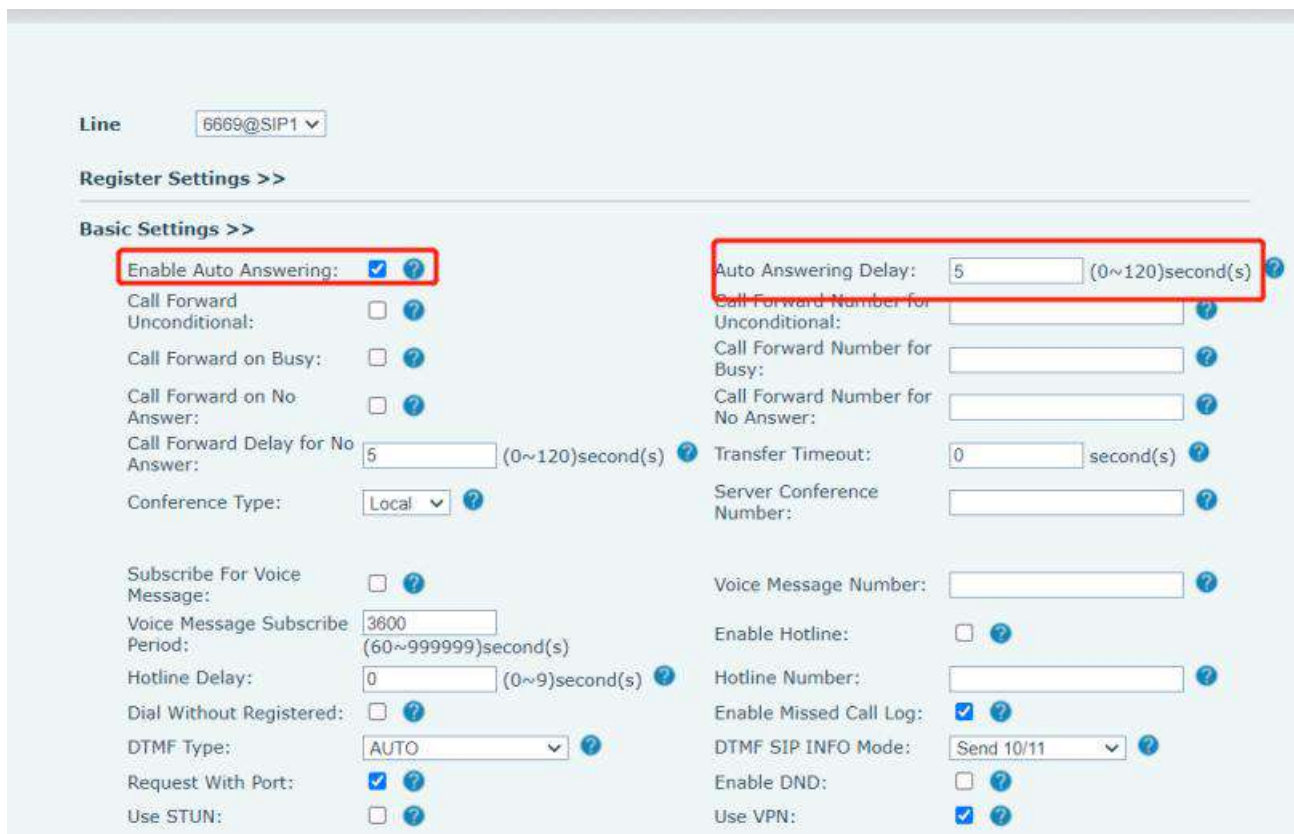

Picture 30 - Web page to start auto-answering

8.7 Callback

The user can dial back the number of the last call. If there is no call history, press the [Callback] button and the phone will say "can't process".

- Set the callback key through the phone interface:
Under standby, press [Menu] >> [Basic] >> [Keyboard] >> [DSS key Settings]. Choose [Call Back] function, input the callback key name, press [OK] key to save.



Picture 31 - Set the callback key on the phone

- Set the callback key through the web interface:

Log in the phone page, enter the **[Function Key]** >> **[Function Key Settings]**, select the function Key, set the type as the function Key, and set the subtype as the callback, as shown in the figure:

Function Key Settings

Dsskey Transfer Mode:

Dsskey Edit:

Key	Type	Name	Value	Subtype	Line	PickUp Number
DSS Key 1	<input type="text" value="Key Event"/> <input type="button" value="v"/>	<input type="text"/>	<input type="text"/>	<input type="text" value="Call Back"/> <input type="button" value="v"/>	<input type="text" value="AUTO"/> <input type="button" value="v"/>	<input type="text"/>

Picture 32 - Set the callback key on the web page

8.8 Mute

You can turn on mute mode during a call and turn off the microphone so that the local voice is not heard. Normally, mute mode is automatically turned off at the end of a call. You can also turn on mute on any screen (such as the free screen) and mute the ringtone automatically when there is an incoming call.

Mute mode can be turned on in all call modes (handles, Headsets or hands-free).

8.8.1 Mute the Call

- Press **[Select]** >> **[Mute]** during a call.

Mute icon is displayed in the call interface, as shown in the figure:

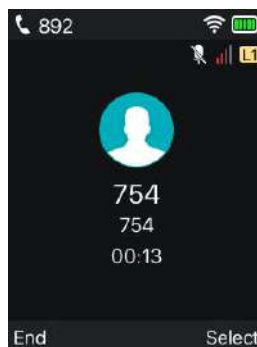

Picture 33 - Mute the call

- Cancel mute: Press **[Select]** >> **[Mute]** again. The mute icon is no longer displayed in the call screen.

8.8.2 Ringing Mute

Users can set shortcut key function key as mute key: Under standby, press **[Menu]** >> **[Basic]** >> **[Keyboard]** >> **[DSS key Settings]**. Choose **[Mute]** function, input the callback key name, press **[OK]** key to

save.

Mute can also be turned on/off with the volume up and down buttons.

Turn on ringing mute

- Press the mute button when the phone is in standby mode.
- Press the volume down key to mute when the phone is in standby

The top right corner of the phone shows the bell mute icon  , Mute button red light is always on, when there is an incoming call, the phone will display the incoming call interface but will not ring.



Picture 34 - Ringing mute

Cancel ring tone mute:

- Press the mute button when the phone is in standby mode.
- Press the volume up key to mute when the phone is in standby.

The mute icon  is no longer displayed in the upper right corner after canceling.

8.9 Call Hold/Resume

The user can press the **[Select] >> [Hold]** button to maintain the current call, and this button will become the **[Select] >> [Resume]** button, and the user can press the **[Select] >> [Resume]** button to restore the call.

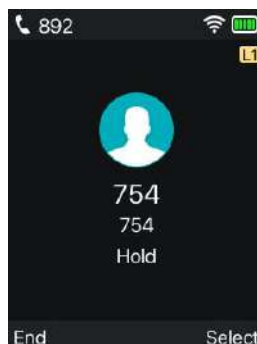

Picture 35 - Call hold interface

8.10 DND

User may enable Do-Not-Disturb (DND) feature on the device to reject incoming calls (including call waiting). The DND can be enabled on line basis.

Phone user interface enable/disable DND

- Enable/Disable phone all lines DND, the methods as the following:
 - 1) Press the **[Menu]** >> **[Features]** >> **[DND]** button to enter the **[DND]** edit page.
 - 2) Use the left/right navigation keys to select the mode as **[Phone]**, and press the **[OK]** key to save after completion.
 - 3) The user will see the DND icon in the status bar, and the device has enabled Do Not Disturb Mode.

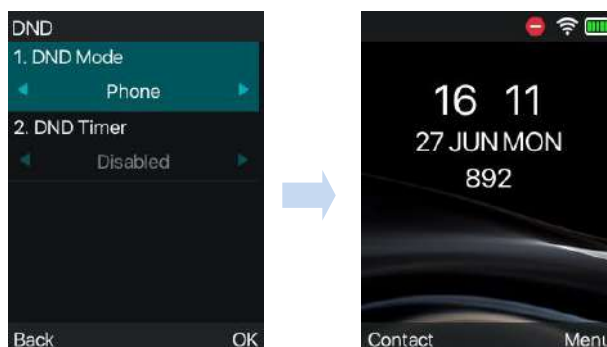

Picture 36 - Enable DND

- If the user wants to enable/disable the uninterrupted function on a specific line, the user can set the methods as the following:
 - 1) Press the **[Menu]** >> **[Features]** >> **[DND]** button to enter the **[DND]** edit page.
 - 2) Use the left/right navigation keys to select the line to adjust the DND mode and status, and press the **[OK]** button to save after completion.
 - 3) The user will see the DND icon in the status bar, and the sip-line has enabled the mode of "DND".

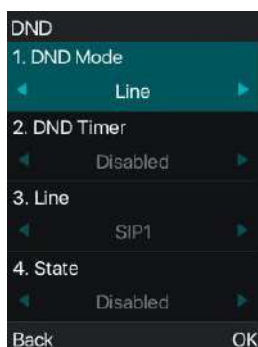

Picture 37 - DND setting interface

- The user can also use the DND timer. After the setting, the DND function will automatically turn on and the DND icon will turn red when ringing.

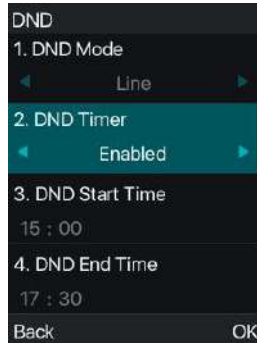

Picture 38 - DND timer

WEB interface enable/disable DND

- After logging into the web page, enter [Phone setting] >> [Features] >> [DND settings], set the DND type (off, phone, line), and DND timing function.

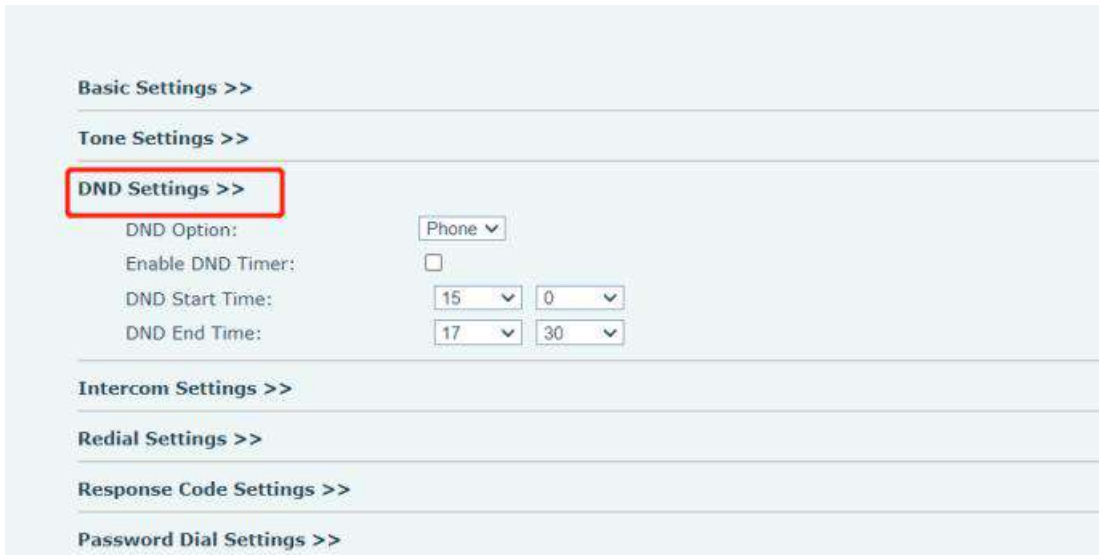

Picture 39 - DND Settings

The user turns on the DND for a specific route on the web page: Enter [Line] >> [SIP], select a [Line] >> [Basic settings], and enable DND.

Line 6669@SIP1 ▾

Register Settings >>

Basic Settings >>

Enable Auto Answering: <input type="checkbox"/> ?	Auto Answering Delay: <input type="text" value="5"/> (0~120)second(s) ?
Call Forward Unconditional: <input type="checkbox"/> ?	Call Forward Number for Unconditional: <input type="text"/> ?
Call Forward on Busy: <input type="checkbox"/> ?	Call Forward Number for Busy: <input type="text"/> ?
Call Forward on No Answer: <input type="checkbox"/> ?	Call Forward Number for No Answer: <input type="text"/> ?
Call Forward Delay for No Answer: <input type="text" value="5"/> (0~120)second(s) ?	Transfer Timeout: <input type="text" value="0"/> second(s) ?
Conference Type: Local ▾ ?	Server Conference Number: <input type="text"/> ?
Subscribe For Voice Message: <input type="checkbox"/> ?	Voice Message Number: <input type="text"/> ?
Voice Message Subscribe Period: <input type="text" value="3600"/> (60~999999)second(s)	Enable Hotline: <input type="checkbox"/> ?
Hotline Delay: <input type="text" value="0"/> (0~9)second(s) ?	Hotline Number: <input type="text"/> ?
Dial Without Registered: <input type="checkbox"/> ?	Enable Missed Call Log: <input checked="" type="checkbox"/> ?
DTMF Type: AUTO ▾ ?	DTMF SIP INFO Mode: Send 10/11 ▾ ?
Request With Port: <input checked="" type="checkbox"/> ?	Enable DND: <input type="checkbox"/> ?
Use STUN: <input type="checkbox"/> ?	Use VPN: <input checked="" type="checkbox"/> ?

Picture 40 - Line DND

8.11 Call Forward

Call forward is also known as 'Call Divert' which is to divert the incoming call to a specific number based on the conditions and configurations. User can configure the call forward settings of each line. There are three types,

- **Unconditional Call Forward** – Forward any incoming call to the configured number.
- **Call Forward on Busy** – When user is busy, the incoming call will be forwarded to the configured number.
- **Call Forward on No Answer** – When user does not answer the incoming call after the configured delay time, the incoming call will be forwarded to the configured number.

Phone interface: Default standby mode

- 1) Press **[Menu]** >> **[Features]** >> **[Call Forward]** button, select the line by up/down navigation key, press **[OK]** button to set call forward.



Picture 41 - Select the line to set up call forwarding

- 2) Select the call forward type by pressing the up/down navigation button. Click [OK] to configure call forwarding and delay time.

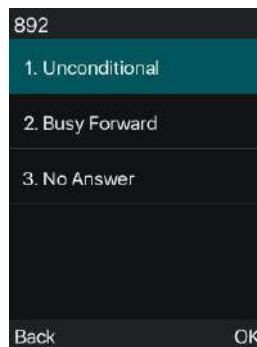

Picture 42 - Select call forward type

- 3) Select enable/disable by pressing the left/right navigation button.

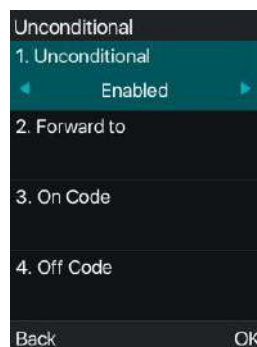

Picture 43 - Enable call forwarding and configure the call forwarding number

- 4) Browse the parameters set by the up/down navigation key and enter the required information. When finished, press the [OK] button to save the changes.

WEB interface: Enter [Line] >> [SIP], Select a [Line] >> [Basic settings], and set the type, number and time of forward forwarding.

Line 6669@SIP1 ▾

Register Settings >>

Basic Settings >>

Enable Auto Answering:	<input type="checkbox"/> ?	Auto Answering Delay:	<input type="text" value="5"/> (0~120)second(s) ?
Call Forward Unconditional:	<input type="checkbox"/> ?	Call Forward Number for Unconditional:	<input type="text"/> ?
Call Forward on Busy:	<input type="checkbox"/> ?	Call Forward Number for Busy:	<input type="text"/> ?
Call Forward on No Answer:	<input type="checkbox"/> ?	Call Forward Number for No Answer:	<input type="text"/> ?
Call Forward Delay for No Answer:	<input type="text" value="5"/> (0~120)second(s) ?	Transfer Timeout:	<input type="text" value="0"/> second(s) ?
Conference Type:	Local ▾ ?	Server Conference Number:	<input type="text"/> ?
Subscribe For Voice Message:	<input type="checkbox"/> ?	Voice Message Number:	<input type="text"/> ?
Voice Message Subscribe Period:	<input type="text" value="3600"/> (60~999999)second(s)	Enable Hotline:	<input type="checkbox"/> ?
Hotline Delay:	<input type="text" value="0"/> (0~9)second(s) ?	Hotline Number:	<input type="text"/> ?
Dial Without Registered:	<input type="checkbox"/> ?	Enable Missed Call Log:	<input checked="" type="checkbox"/> ?
DTMF Type:	AUTO ▾ ?	DTMF SIP INFO Mode:	Send 10/11 ▾ ?
Request With Port:	<input checked="" type="checkbox"/> ?	Enable DND:	<input type="checkbox"/> ?
Use STUN:	<input type="checkbox"/> ?	Use VPN:	<input checked="" type="checkbox"/> ?

Picture 44 - Set call forward

8.12 Call Transfer

When the user is talking with a remote party and wish to transfer the call to another remote party, there are three way to transfer the call, blind transfer, attended transfer and Semi-Attended transfer.

- Blind transfer: No need to negotiate with the other side, directly transfer the call to the other side.
- Semi-Attended transfer: When you hear the ring back, transfer the call to the other party.
- Attended transfer: When the caller answers the call, transfer the call to the other party.

Note ! For more transfer Settings, please refer to [12.6 Line >> Dial Plan](#)

8.12.1 Blind transfer

During the call, the user presses the function menu button [Xfer] , Enter the number to transfer or press the contact button or the history button to select the number, press the transfer key again to a third party. After the third party rings, the phone will show that the transfer is successful and hang up.

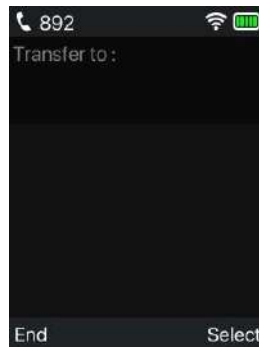

Picture 45 - Transfer interface

8.12.2 Semi-Attended transfer

During the call, the user presses the function menu button [transfer] to input the number to be transferred or press the contact button or the historical record button to select the number, and then press the call button. When the third party is not answered, press the transfer on the call interface to make the semi-attendance transfer or press the end button to cancel the semi-attendance transfer.

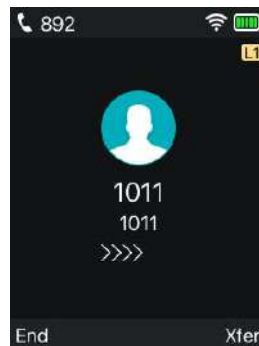

Picture 46 - Semi-Attended transfer

8.12.3 Attended transfer

Attendance transfer is also known as "courtesy mode", which is to transfer the call by calling the other party and waiting for the other party to answer the call.

The same procedure to calling. In dual call mode, press the "transfer" button to transfer the first call to the second call.

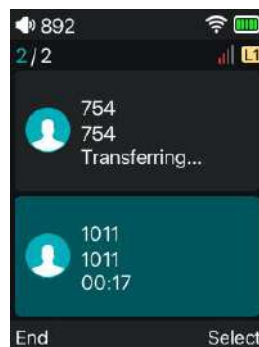

Picture 47 - Attended transfer

8.13 Call Waiting

- Enable call waiting: new calls can be accepted during a call.
- Disable call waiting: new calls will be automatically rejected and a busy tone will be prompted.
- Enable call waiting tone: when you receive a new call on the line, the tone will beep.

The user can enable/disable the call waiting function in the phone interface and the web interface.

- Phone interface: Press **[Menu]** >> **[Features]** >> **[Call waiting]**, the navigation key and left/right button enable/disable call waiting and call waiting tone.

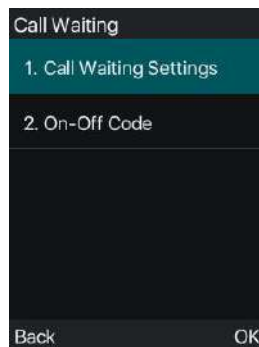

Picture 48 - Call waiting setting

WEB interface: Enter **[Phone Settings]** >> **[Features]** >> **[Basic Settings]**, enable/disable call waiting and call waiting tone.

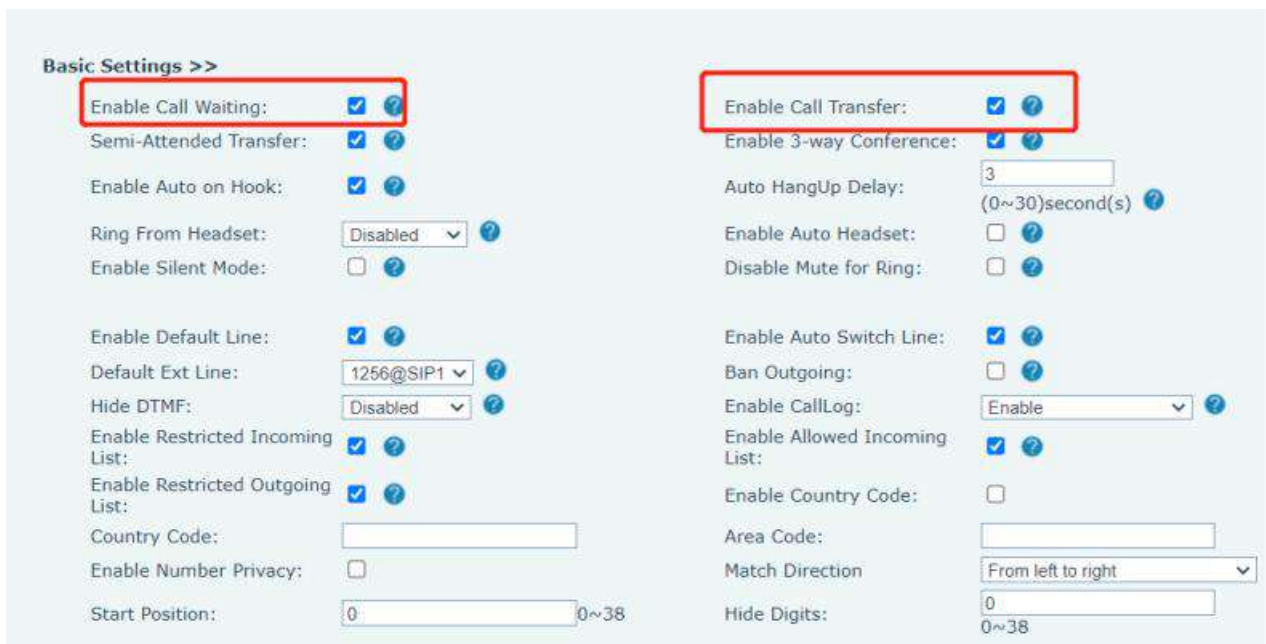

Picture 49 - Web call waiting setting

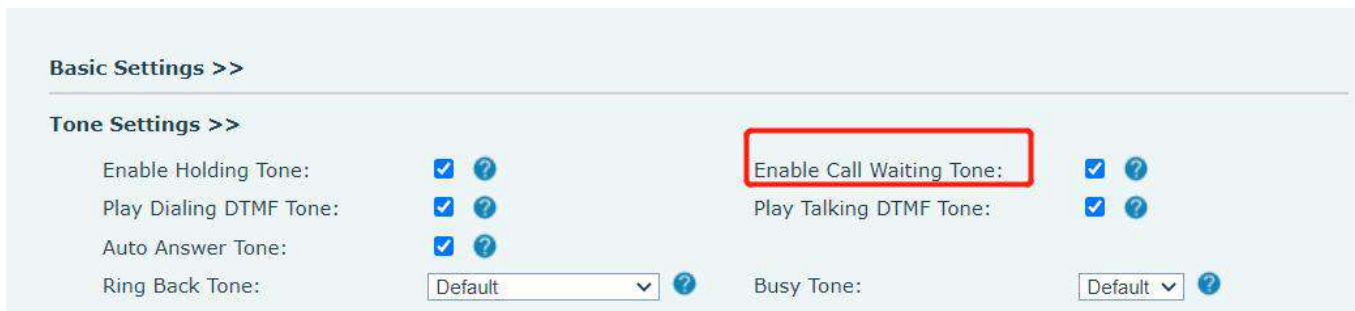

Picture 50 - Web call waiting tone setting

8.14 Conference

8.14.1 Local Conference

To conduct local conference, the user needs to log in the webpage and enter [Line] >> [SIP] >> [Basic settings]. The meeting mode is set as local (the default is local mode), as shown in the figure:

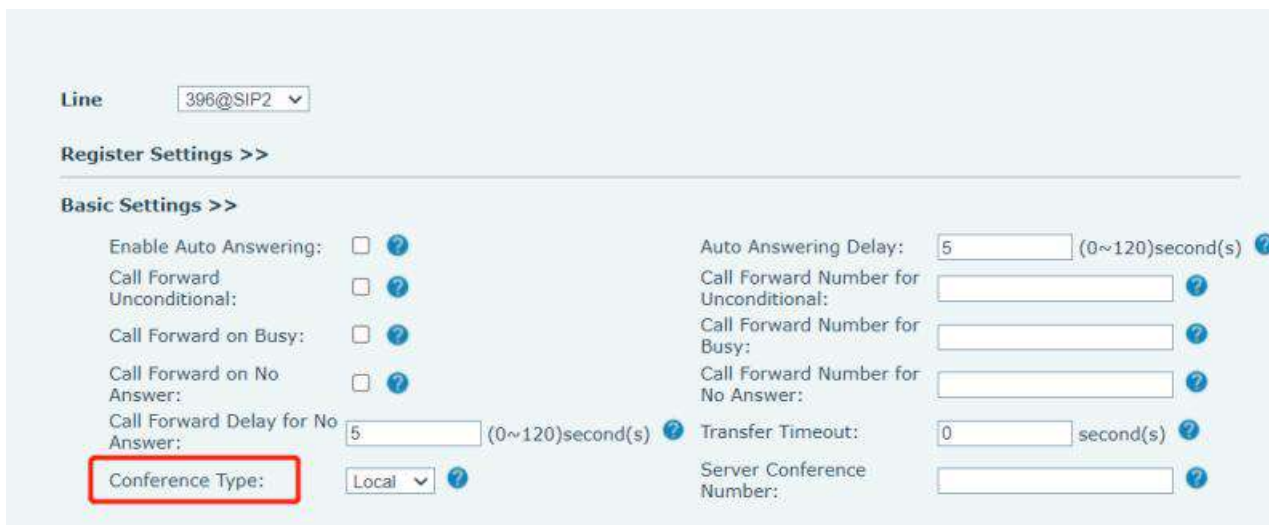

Picture 51 - Local conference setting

Two ways to create a local conference:

1) The device has two calls, press the conference button on the call interface, select another existing number when selecting the conference number, and press the confirm button to establish a local 3-way conference as shown in the figure.

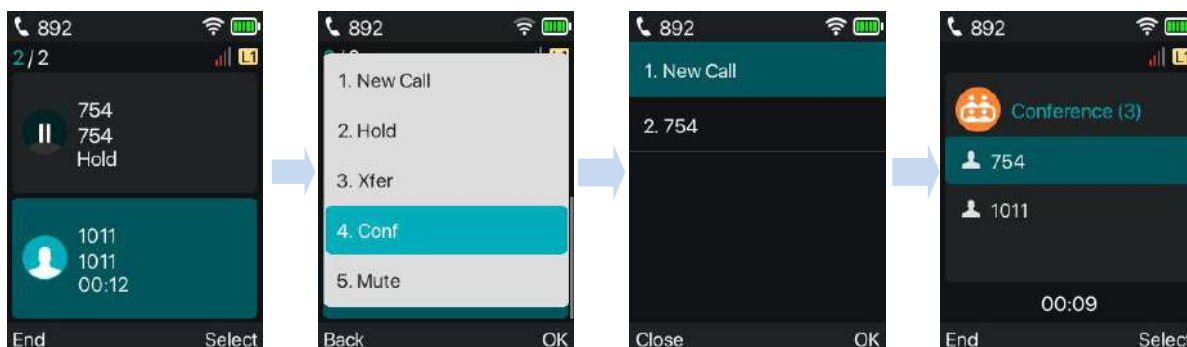

Picture 52 - Local conference (1)

2) There is a call on the device, press the conference button on the call interface, enter the number to join the conference, and press the call; after the opposite end answers, press the conference button again to establish a local three-party conference. As shown in the figure:

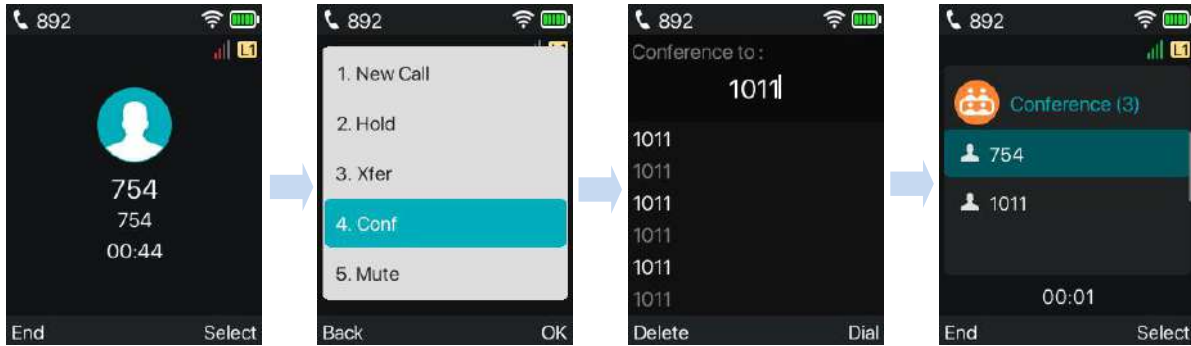

Picture 53 - Local conference (2)

Note: During a conference, press the [Select] >> [Separate] key to separate the conference, and press the end key to end the call.

8.14.2 Network Conference

Users need server support for network conference.

Log in the web page, enter [Line] >> [SIP] >> [Basic settings], set the conference mode as server mode (default is local mode), set the server conference room number (please consult your system administrator), as shown in the figure:

Basic Settings >>

Enable Auto Answering: <input type="checkbox"/>	Auto Answering Delay: 5 (0~120)second(s)
Call Forward Unconditional: <input type="checkbox"/>	Call Forward Number for Unconditional: <input type="text"/>
Call Forward on Busy: <input type="checkbox"/>	Call Forward Number for Busy: <input type="text"/>
Call Forward on No Answer: <input type="checkbox"/>	Call Forward Number for No Answer: <input type="text"/>
Call Forward Delay for No Answer: 5 (0~120)second(s)	Transfer Timeout: 0 second(s)
Conference Type: Local	Server Conference Number: <input type="text"/>
Subscribe For Voice Message: <input type="checkbox"/>	Voice Message Number: <input type="text"/>
Voice Message Subscribe Period: 3800 (60~999999)second(s)	Enable Hotline: <input type="checkbox"/>
Hotline Delay: 0 (0~9)second(s)	Hotline Number: <input type="text"/>
Dial Without Registered: <input type="checkbox"/>	Enable Missed Call Log: <input checked="" type="checkbox"/>
DTMF Type: AUTO	DTMF SIP INFO Mode: Send 10/11
Request With Port: <input checked="" type="checkbox"/>	Enable DND: <input type="checkbox"/>
Use STUN: <input type="checkbox"/>	Use VPN: <input checked="" type="checkbox"/>
Enable Failback: <input checked="" type="checkbox"/>	Signal Failback: <input type="checkbox"/>
Failback Interval: 1800 second(s)	Signal Retry Counts: 3 (1~10)

Picture 54 - Network conference

Method to join a network conference:

- Multi-way call number of network conference room and enter the password then all enter the conference room.
- The two phones have established common calls. Press the conference button to invite new members to the conference. Follow the voice prompt to operate.

Note: the upper limit of the number of participants in the network conference varies according to the server.

8.15 Anonymous Call

8.15.1 Anonymous Call

The phone can set up anonymous calls to hide the calling number and the calling name.

- You can see anonymity in the context of [Menu] >> [Advanced] >> [Accounts] >> [SIP Line] >> [Advanced].
- The default is none, which is off, and RFC3323 and RFC3325 are optional.
- Select any one to open the anonymous call.

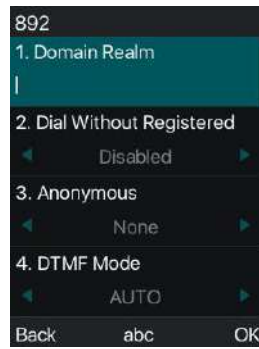

Picture 55 - Enable anonymous call

- On the web page [Line] >> [SIP] >> [System] can also open the mode of anonymous calls.
- Setting to enable anonymous calls also corresponds to the SIP line. That is, the setting under the SIP1 page can only take effect on the SIP1 line.

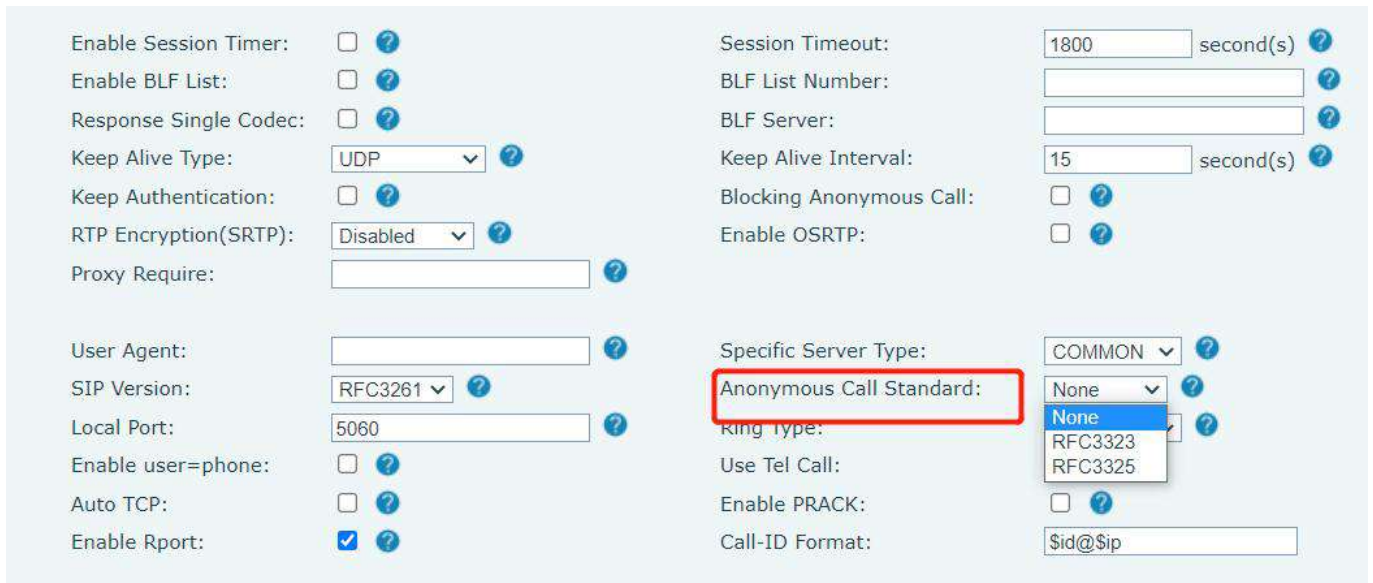

Picture 56 - Enable Anonymous web page call

The following is a transcript of an anonymous call received by the phone.

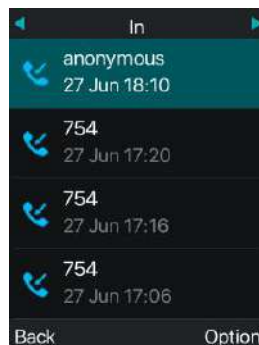

Picture 57 - Anonymous call log

8.15.2 Ban Anonymous Call

The device can be set to prohibit anonymous calls, that is anonymous calls to the number will be directly rejected.

- In the phone [Menu] >> [Features] >> [Ban anonymous call], click to enter and all SIP lines will be displayed.
- Click Softkey [Switch] or [<] [>] to switch the SIP line and enable anonymous call.



Picture 58 - Anonymous calls are not allowed on the phone

- On the web page [Line] >> [SIP] >> [System], also can disable anonymous calls.
- The setup to disable anonymous calls also corresponds to the SIP line. That is, the setting under the SIP1 page can only take effect on the SIP1 line.

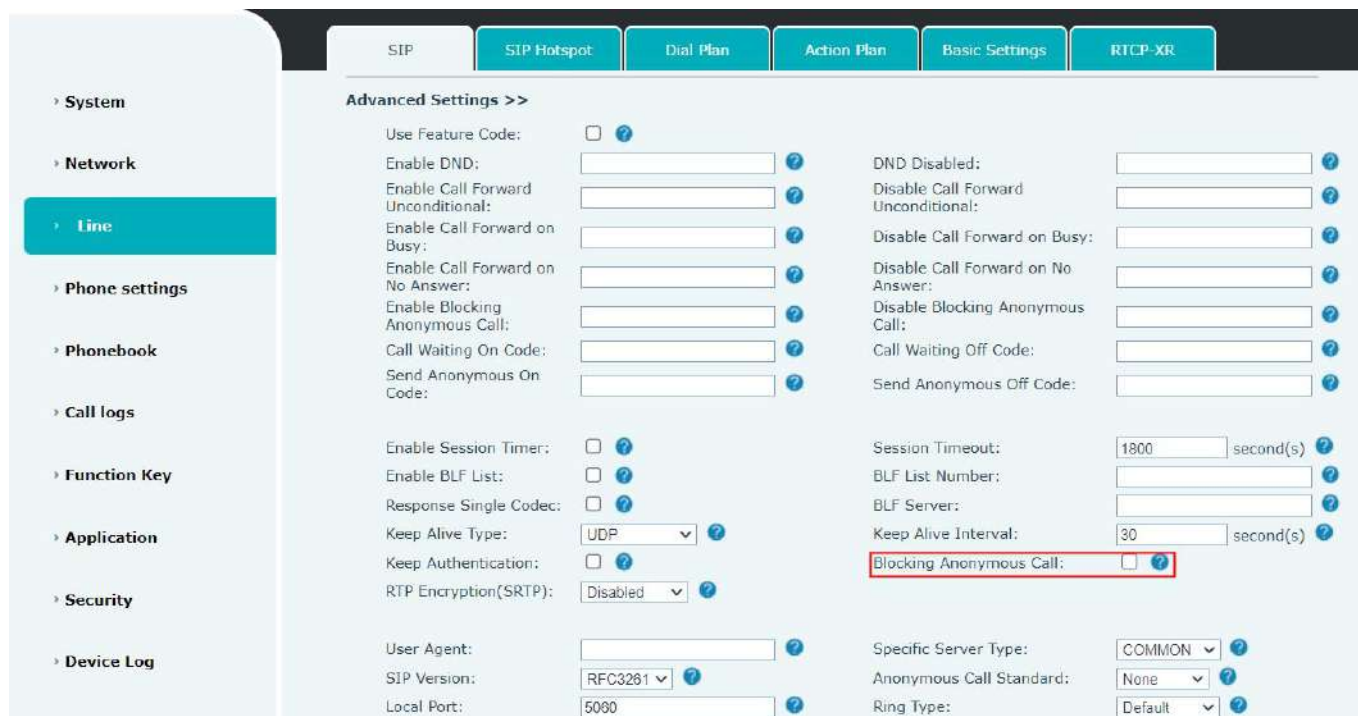

Picture 59 - Page Settings blocking anonymous call

8.16 Hotline

The device supports hotline dialing. After setting up the hotline dialing, directly pick up the handset, hands-free, Headset, etc., and the phone will automatically call according to the hotline delay time.

- In the phone **[Menu]** >> **[Features]** >> **[Advanced]** >> **[Hotline]**, click to enter and all SIP lines will be displayed.
- Then set the hotline for each SIP line, which is off by default.
- Open the hotline, set the hotline number, set the delay time of the hotline.

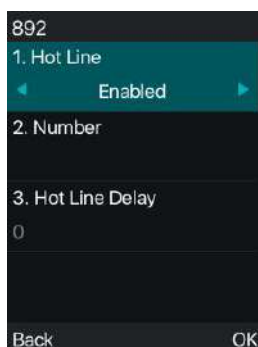

Picture 60 - Phone hotline setting interface

- On the website **[Line]** >> **[SIP]** >> **[Basic Settings]**, can also set up a hotline.
- The setup hotline also corresponds to the SIP line. That is, the hotline set in the SIP1 webpage can only be activated in the SIP1 line.

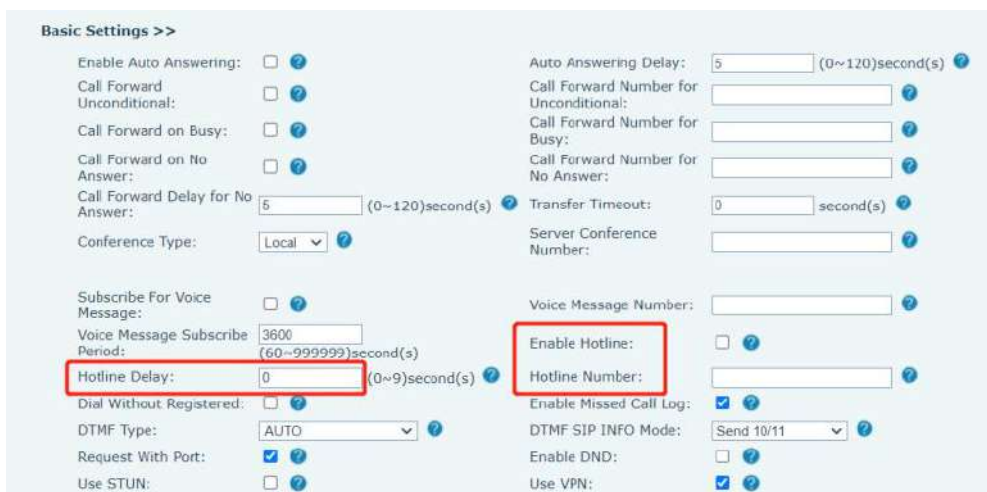

Picture 61 - Hotline set up on webpage

8.17 Emergency Call

The emergency call function is used to set the corresponding emergency call number on the phone after enabling the keypad lock. You can also call emergency services when your phone is locked.

- 1) Configure the emergency call number: log in the phone page, enter the [Phone Settings] >> [Function Settings]>> [Basic Settings]page, set up the emergency call code, if you need to set up more than one emergency call code, please use ", "to separate.

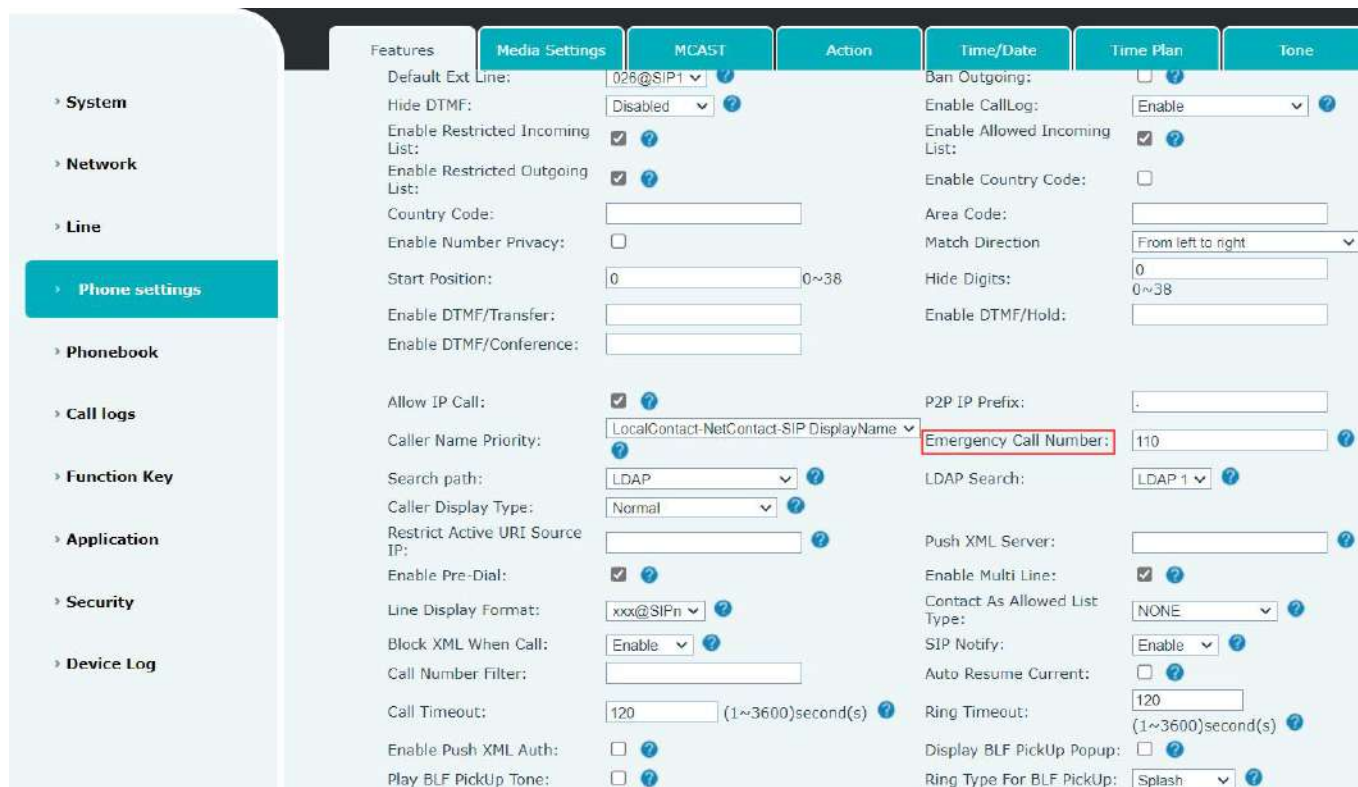

Picture 62 - Set up an emergency call number

- 2) When the phone set the keyboard lock, you can call the emergency call number without unlocking, as shown in the figure:

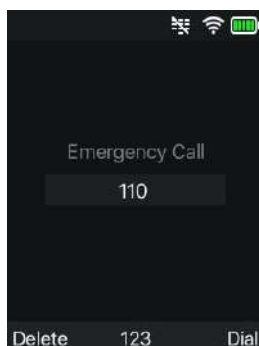

Picture 63 - Dial the emergency number

9 Advance Function

9.1 Record

The device supports recording during a call.

9.1.1 Server Record

When using the network server to record, it is necessary to open the recording in the phone web page [Application] >> [Manage recording]. The type is selected as network, and the address and port of the recording server are filled in and the voice coding is selected. The web is as follows:

Record Setting

Enable Record:

Record Type: Network

Voice Codec: PCMU

Server Address: 0.0.0.0 Server Port: 10000

Auto Cover Older Recordings:

Apply

Recording List

Index	File Name	File Size
Delete		

Picture 64 - Web server recording

Note: to be used with Fanvil recording software.

9.1.2 SIP INFO Record

The phone is registered with a server that supports SIP INFO recording. After registering the account, check the recording module of [Application] >> [Record Setting] to open the recording, and the record type is SIP INFO.

Record Setting

Enable Record:

Record Type: Sip Info

Auto Cover Older Recordings:

Apply

Recording List

Index	File Name	File Size
Delete		

Picture 65 - Web SIP info recording

9.2 Agent

Agent (Agent function) of the phone can be realized: when multiple people use a device for Agent services at different times, he or she can quickly register his or her SIP account on the same server. The Agent functions of the phone can be divided into Normal and Hotel Guest. The Hotel Guest mode requires server support.

Normal Mode:

Configure agent function: set a DSSKey as agent, press the function key or enter the **[Menu]** >> **[Features]** >> **[Agent]** to enter the agent page. The SIP server needs to be configured before the account can be configured.

Note: The password to enter the proxy configuration is the same as the menu password, the default is 123.

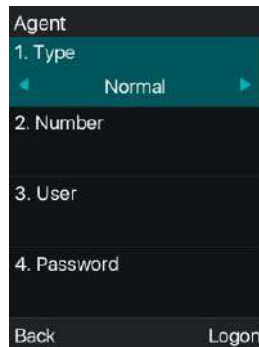

Picture 66 - Configure the agent account in normal mode

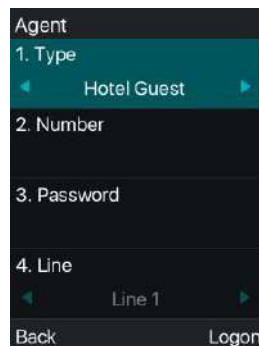

Picture 67 - Configure the proxy account-hotel Guest mode

Table 7 - Agency mode

Parameter	Description
Normal mode	
Number	Set the proxy account number.

User	Set the proxy account number to verify the user name.
Password	Set the proxy account number to verify the password.
Line	Select the SIP line.
Hotel Guest mode	
Number	Set the proxy account number.
User	Set the proxy account number to verify the user name.
Password	Set the proxy account number to verify the password.
Line	Select the SIP line.
CallLog	Users can choose to save all types, or delete.
Status	The user can select the status of the number, including Login, Logout, Unavailable, Available, and Wrap-up

Using agent functions:

- 1) When the phone has been configured on SIP server, fill in the correct number and user name password, click login and then the phone can be registered to the SIP server;
- 2) After registration, click logout and the phone can delete the user name and password, and log out of the SIP account.
- 3) Click Unregister and the phone retains the user name and password, and logs out of the SIP account.



Picture 68 - Agent logon page

9.3 Intercom

When the Intercom is enabled, it can automatically receive calls from the intercom.

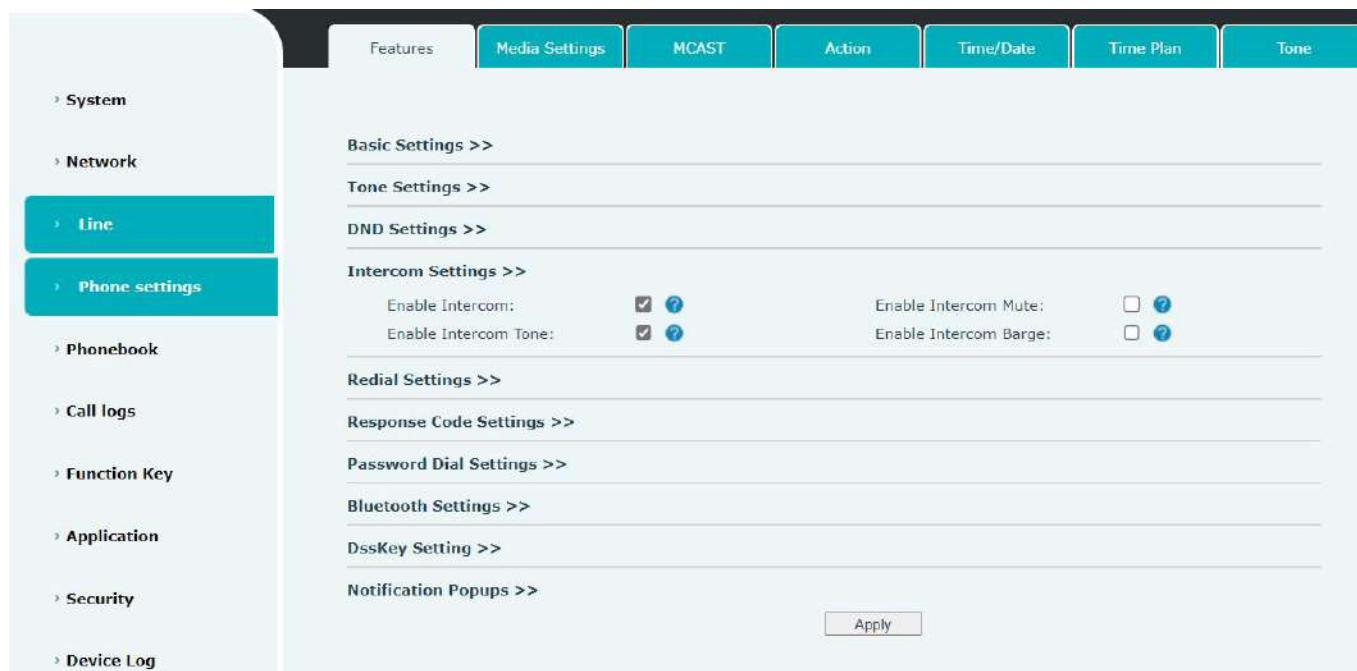

Picture 69 - Web Intercom configure

Table 8 - Intercom configure

Parameter	Description
Enable Intercom	When intercom is enabled, the device will accept the incoming call request with a SIP header of Alert-Info instruction to automatically answer the call after specific delay.
Enable Intercom Mute	Enable mute mode during the intercom call
Enable Intercom Tone	If the incoming call is intercom call, the phone plays the intercom tone
Enable Intercom Barge	Enable Intercom Barge by selecting it, the phone auto answers the intercom call during a call. If the current call is intercom call, the phone will reject the second intercom call

9.4 MCAST

This feature allows user to make some kind of broadcast call to people who are in multicast group. User can configure a multicast DSS Key on the phone, which allows user to send a Real Time Transport Protocol (RTP) stream to the pre-configured multicast address without involving SIP signaling. You can also configure the phone to receive an RTP stream from pre-configured multicast listening address without involving SIP signaling. You can specify up to 10 multicast listening addresses.

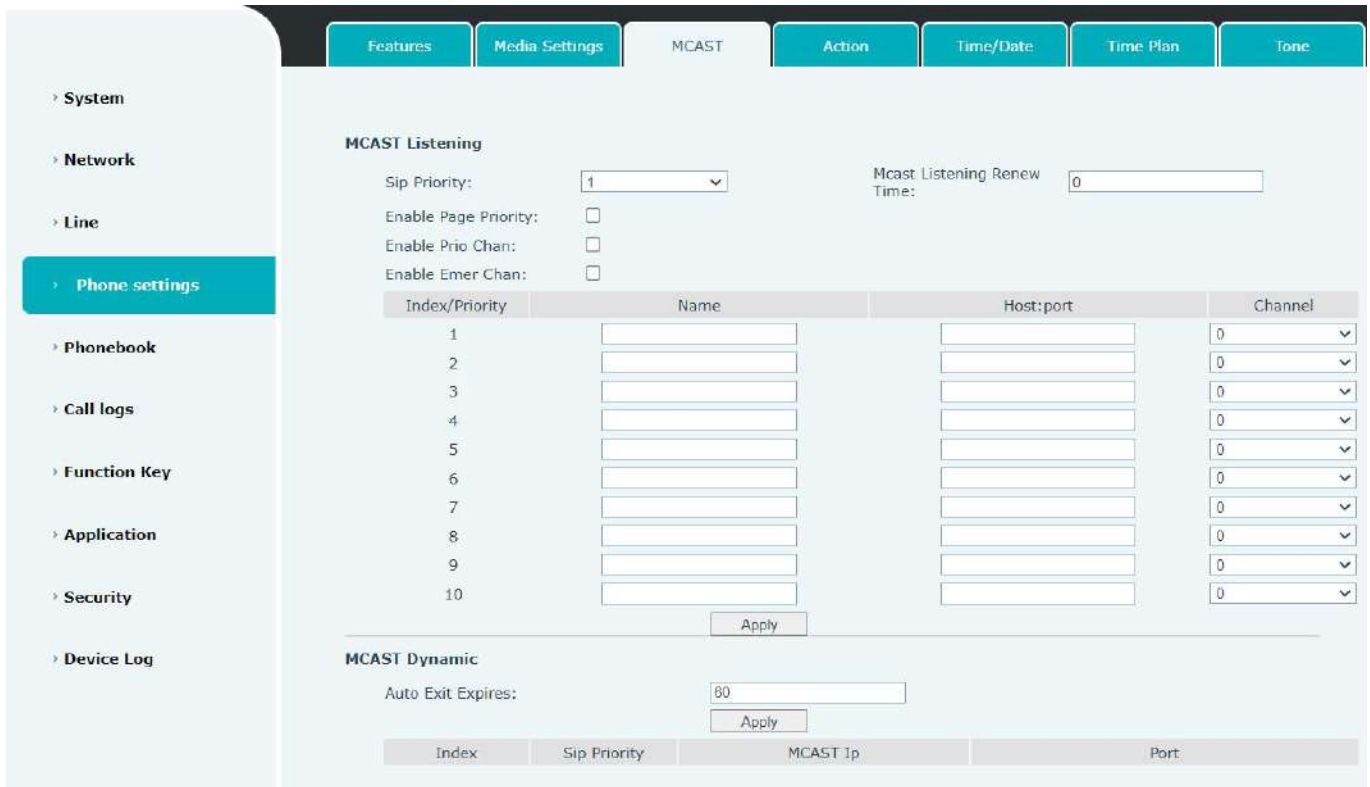

Picture 70 - Multicast Settings Page

Table 9 - MCAST Parameters on Web

Parameters	Description
Normal Call Priority	Define the priority of the active call, : 1-10: Define the priority of normal calls, 1 is the highest priority, 10 is the lowest.
Enable Page Priority	The voice call in progress shall take precedence over all incoming paging calls.
Name	Listened multicast server name
Host:port	Listened multicast server’s multicast IP address and port.

Multicast:

- Go to web page of [Function Key] >> [Function Key] , select the type to multicast, set the multicast address, and select the codec.
- Click Apply.
- Set up the name, host and port of the receiving multicast on the web page of [Phone Settings] >> [MCAST].
- Press the DSSKY of Multicast Key which you set.
- Receive end will receive multicast call and play multicast automatically.

9.5 Message

9.5.1 SMS

If the service of the line supports the function of the short message, when the other end sends a text message to the number, the user will receive the notification of the short message and display the icon of the new SMS on the standby screen interface.

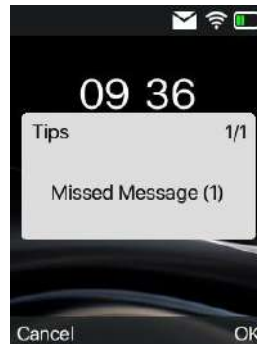

Picture 71 - SMS icon

Send messages:

- Go to [**Menu**] >> [**Message**] >> [**SMS**].
- Users can create new messages, select lines and send numbers.
- After editing is completed, click Send.

View SMS:

- Go to [**Menu**] >> [**Message**] >> [**SMS**].
- Select [**Inbox**] to enter the SMS inbox interface.
- Select the unread message and press [**OK**] to read the unread message.

Reply to SMS:

- Go to [**Menu**] >> [**Message**] >> [**SMS**].
- Select [**Inbox**] to enter the SMS inbox interface.
- Select the message you want to reply to, select [**Option**] >> [**Reply**], edit it, and click Send.

9.5.2 MWI (Message Waiting Indicator)

If the service of the lines supports voice message feature, when the user is not available to answer the call, the caller can leave a voice message on the server to the user. User will receive voice message notification from the server and device will prompt a voice message waiting icon on the standby screen.

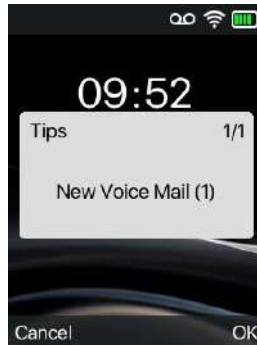

Picture 72 - New Voice Message Notification

Voice message icon

To listen to a voice message, the user must first configure the voicemail number. After the voicemail number is configured, the user can retrieve the voicemail of the default line.

When the phone is in the default standby state,

- Access **[Menu]>>[Message]>>[Voice Message]**
- Open the voice message configuration interface, and select the line to be configured by pressing the up/down navigation buttons.
- Press the **[Edit]** button to edit the voice message number. When finished, press the **[OK]** button to save the configuration.
- SIP1(m/n), “m” in front of Fanvil line brackets represents unread voice messages, and “n” represents the total number of voice messages.

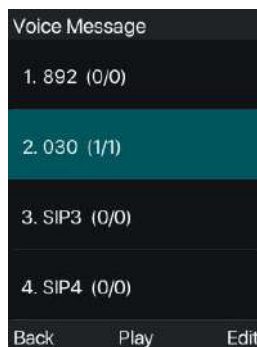

Picture 73 - Voice message interface

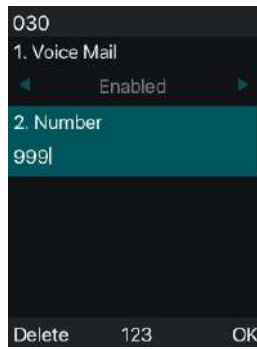

Picture 74 - Configure voicemail number

9.6 SIP Hotspot

SIP hotspot is a simple but practical function. With simple configurations, the SIP hotspot function can implement group ringing. SIP accounts can be expanded.

The users can set functions as a SIP hotspot and other phones set (B and C) function as SIP hotspot clients. When somebody calls phone set A, phone sets A, B, and C all ring at the same time. When any phone set answers the call, other phone sets stop ringing. The call can be answered by only one phone set. When B or C initiates a call, the SIP number registered by phone set A is the calling number.

To set a SIP hotspot, register at least one SIP account.

Line 1256@SIP1

Register Settings >>

Line Status:	Registered	Activate:	<input checked="" type="checkbox"/> ?
Username:	<input type="text" value="1256"/> ?	Authentication User:	<input type="text"/> ?
Display name:	<input type="text"/> ?	Authentication Password:	<input type="text"/> ?
Realm:	<input type="text"/> ?	Server Name:	<input type="text"/> ?

SIP Server 1:		SIP Server 2:	
Server Address:	<input type="text" value="172.16.1.2"/> ?	Server Address:	<input type="text"/> ?
Server Port:	<input type="text" value="5060"/> ?	Server Port:	<input type="text" value="5060"/> ?
Transport Protocol:	<input type="text" value="UDP"/> ?	Transport Protocol:	<input type="text" value="UDP"/> ?
Registration Expiration:	<input type="text" value="3600"/> second(s) ?	Registration Expiration:	<input type="text" value="3600"/> second(s) ?

Proxy Server Address:	<input type="text"/> ?	Backup Proxy Server Address:	<input type="text"/> ?
Proxy Server Port:	<input type="text" value="5060"/> ?	Backup Proxy Server Port:	<input type="text" value="5060"/> ?
Proxy User:	<input type="text"/> ?		
Proxy Password:	<input type="text"/> ?		

Picture 75 - Register SIP account

Table 10 - SIP hotspot Parameters

Parameters	Description
Device Table	If your phone is set to "SIP hotspot server", Device Table will display as Client Device Table which connected to your phone. If your phone is set to "SIP hotspot client", Device Table will display as Server Device Table which you can connect to.
SIP hotspot	
Enable hotspot	Set it to be Enable to enable the feature.
Mode	Choose hotspot, phone will be a "SIP hotspot server"; Choose Client, phone will be a "SIP hotspot Client"
Monitor Type	Either the Multicast or Broadcast is ok. If you want to limit the broadcast packets, you'd better use broadcast. But, if client choose broadcast, the SIP hotspot phone must be broadcast.
Monitor Address	The address of broadcast, hotspot server and hotspot client must be same.
Remote Port	Type the Remote port number.

Configure SIP hotspot server:

The screenshot displays the configuration interface for a SIP hotspot server. It is divided into three main sections:

- Client Table:** A table with columns for IP, MAC, Alias, and Line. It shows one entry with IP 172.16.7.150, MAC 0c:38:3e:36:d0:6f, Alias 1, and Line 2,1.
- SIP Hotspot Settings:** A form with the following fields:
 - Enable Hotspot: Enabled (dropdown)
 - Mode: Hotspot (dropdown)
 - Monitor Type: Broadcast (dropdown)
 - Monitor Address: 224.0.2.0 (text input)
 - Local Port: 16360 (text input)
 - Name: SIP Hotspot (text input)
 - Ring Mode: All (dropdown)
- Line Settings:** A form with the following fields:
 - Line 1: Enabled (dropdown)
 - Ext Prefix 1: (empty text input)

Picture 76 - SIP hotspot server configuration

Configure SIP hotspot client:

To set as a SIP hotspot client, no SIP account needs to be set. The Phone set will automatically obtain and configure a SIP account. On the SIP Hotspot tab page, set Mode to Client. The values of other options are the same as those of the hotspot.

Hotspot Table

IP	Server name	Online Status	Connection Status	Alias	Line	
172.16.7.160	SIP Hotspot	OnLine	Disconnected			Connect
172.16.7.150	SIP Hotspot	OnLine	Connected	1	1	Disconnect

SIP Hotspot Settings

Enable Hotspot: ?

Mode: ?

Monitor Type: ?

Monitor Address: ?

Local Port: ?

Name: ?

Line Settings

Line 1:

Line 2:

Picture 77 - SIP hotspot client configuration

As the hotspot server, the default extension number is 0. When the phone is used as the client, the extension number is increased from 1, you can view the extension number through the [SIP Hotspot] page.

Call extension number:

- The hotspot server and the client can dial each other through the extension number.
- For example, extension 1 dials extension 0.

10 Phone Settings

10.1 Basic Settings

10.1.1 Language

The user can set the phone language through the phone interface and web interface.

- Phone end: After resetting the factory settings, the user needs to set the language; when setting the language during standby, go to [Menu] >> [Basic] >> [Language] Settings, as shown in the figure.

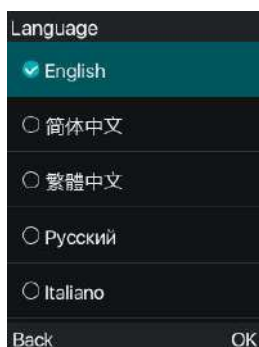

Picture 78 - Phone language setting

- Web interface: Log in to the phone webpage and set the language in the drop-down box at the top right corner of the page, as shown in the figure:

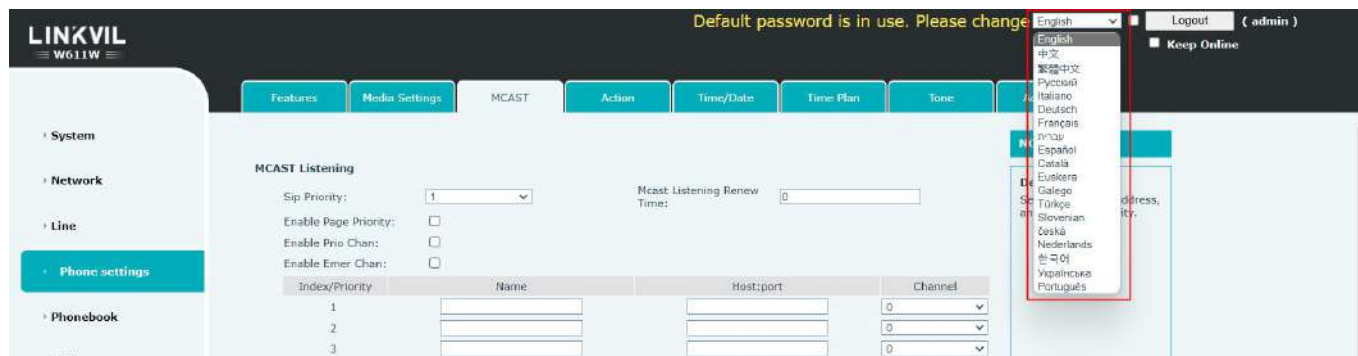

Picture 79 - Language setting on Web page

- The function box on the right side of the web interface language setting box is “Synchronize language to phone”; if selected, the phone language will be synchronized with the webpage language. If it is not selected, it will not be synchronized.

10.1.2 Time & Date

Users can set the phone time through the phone interface and web interface.

- Phone end: When the phone is in the default standby state, press the [Menu] >> [Basic] >> [Time & Date] , use the up/down navigation button to edit parameters, press the [OK] to save after completion, as shown in the figure:

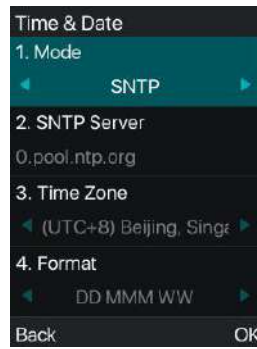

Picture 80 - Set time & date on phone

- Web end: Log in to the phone webpage and enter [Phone Settings] >> [Time/Date] , as shown in the figure:

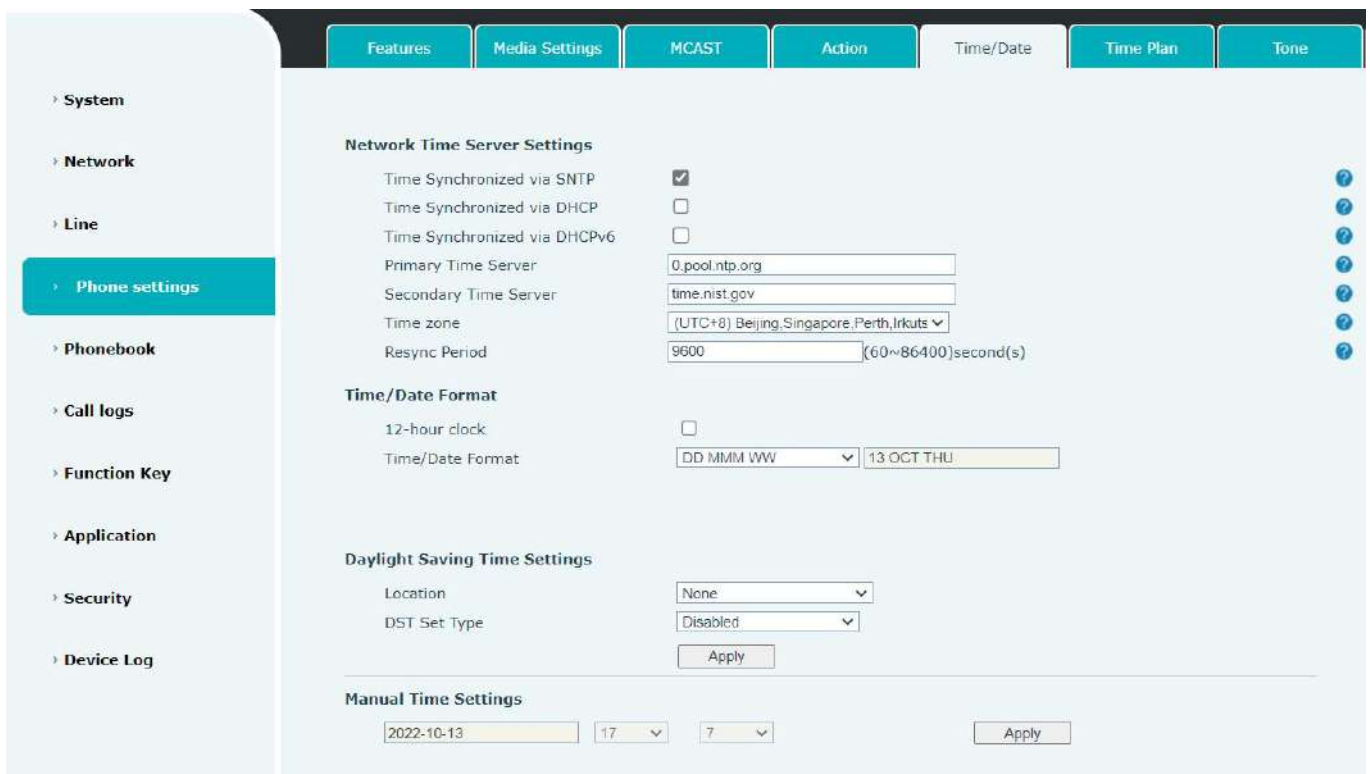

Picture 81 - Set time & date on webpage

Table 11 - Time Settings Parameters

Parameters	Description
Mode	Auto/Manual Auto: Enable network time synchronization via SNTP protocol, default enabled. Manual: User can modify data manually.
SNTP Server	SNTP server address
Time zone	Select the time zone

Time format	<p>Select time format from one of the followings:</p> <ul style="list-style-type: none"> ■ 1 JAN, MON ■ 1 January, Monday ■ JAN 1, MON ■ January 1, Monday ■ MON, 1 JAN ■ Monday, 1 January ■ MON, JAN 1 ■ Monday, January 1 ■ DD-MM-YY ■ DD-MM-YYYY ■ MM-DD-YY ■ MM-DD-YYYY ■ YY-MM-DD ■ YYYY-MM-DD
Separator	Choose the separator between year and moth and day
12-Hour Clock	Display the clock in 12-hour format
Daylight Saving Time	Enable or Disable the Daylight Saving Time

10.1.3 Screen

The user can set the phone screen parameters through both of the phone interface and web interface.

- Phone: When the phone is in the default standby state, go to **[Menu]** >> **[Basic]** >> **[Screen]** to edit the screen parameters. After editing, click **[OK]** to save, as shown in the figure:

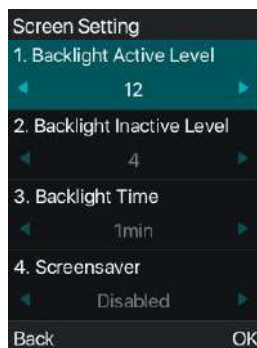

Picture 82 - Set screen parameters on phone

- Web : Go to **[Phone Settings]** >> **[Advanced]**, edit the screen parameters, and click Apply to save.

10.1.3.1 Brightness and backlight

- Set the brightness level in use from 1 to 16, [**<**] or [**>**] switch brightness level.
- Set the brightness level in the energy-saving mode from 0 to 16, [**<**] or [**>**] switch the brightness level.
- Set the backlight time to 1 mins by default. You can turn it off or select 15 seconds /30 seconds /45

seconds /60 seconds /90 seconds /120 seconds.

- Web interface: enter [**Phone Settings**] >> [**Advanced**], edit screen parameters, and click submit to save.

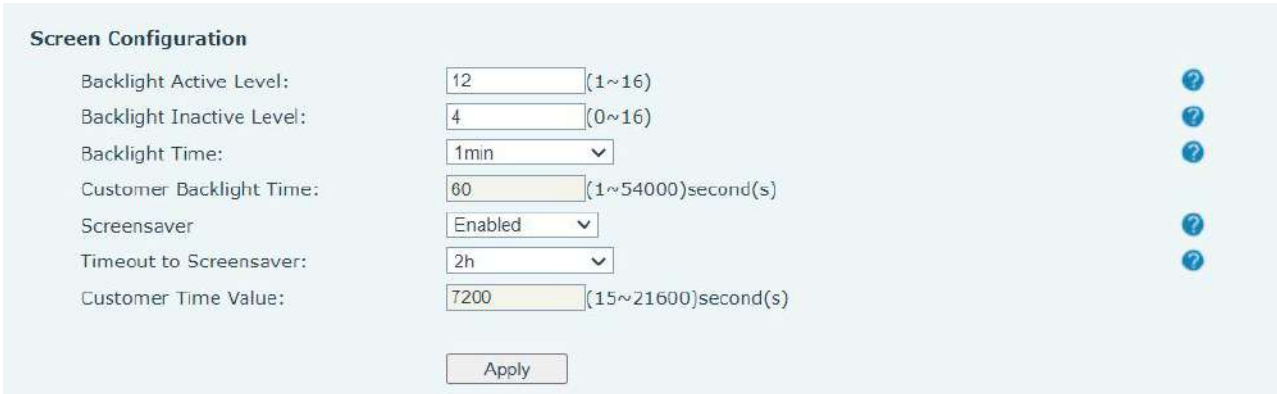

Picture 83 - Page screen Settings

10.1.3.2 Screen Saver

- Press [**Screen Settings**] to find the [**Screen protection**] button, press [**left**] / [**right**] button to open/close the screen protection, set the timeout time, the default is 15S, after completion, press [**OK**] button to save.
- After saving, return to standby mode and enter the screen saver after 15s, as follows:



Picture 84 - Phone screen saver

10.1.4 Ring

When the device is in the default standby mode,

- Press soft-button [**Menu**] till you find the [**Basic**] item.
- Enter [**Basic**] item till you find [**Ring**] item.
- Enter [**Ring**] item and you will find [**Headset**] or [**Handsfree**] item, press left / right navigator keys to adjust the ring volume, save the adjustment by pressing [**OK**] when done.
- Enter [**Ring type**] item, press left / right navigator keys to change the ring type, save the adjustment by pressing [**OK**] when done.

10.1.5 Voice Volume

When the device is in the default standby mode,

- Press soft-button **[Menu]** till you find the **[Basic]** item.
- Enter **[Basic]** item till you find **[Voice Volume]** item.
- Enter **[Voice Volume]** item and you will find **[Headset]**, **[Handsfree]** and **[Headset]** item.
- Enter **[Headset]** or **[Handsfree]** or **[Headset]** item, press Left / Right navigator keys to adjust the audio volume for different mode.
- Save the adjustment by pressing **[OK]** when done.

10.1.6 Greeting Words

When the device is in the default standby mode,

- Press soft-button **[Menu]** till you find the **[Basic]** item.
- Enter **[Basic]** item till you find **[Greeting Words]** item.
- Press **[OK]** to enter the setting interface to edit the Greetings Words.
- Save the adjustment by pressing **[OK]** when done.

NOTICE! *The welcome message can only be displayed in the upper left corner of standby mode when the default option is disabled.*

10.1.7 Reboot

When the device is in the default standby mode,

- Press soft-button **[Menu]** till you find the **[Basic]** item.
- Enter **[Basic]** item till you find **[Reboot]** item.
- Press **[OK]** a prompt message, "restart now," prompts the user.
- Press **[OK]** to restart the phone or **[Cancel]**.

The phone is in standby mode,

- The configurable **[OK]** key is the restart key. Press **[OK]**, a prompt message, "restart now" prompts the user.
- Press **[OK]** to restart the phone or **[Cancel]** to exit.

10.2 Phone Book

10.2.1 Local Contact

User can save contacts' information in the phone book and dial the contact's phone number(s) from the phone book. To open the phone book, user should press **[Menu]>> [Contact]** in the default standby screen or keypad.

By default the phone book is empty, user may add contact(s) into the phone book manually or from call logs.

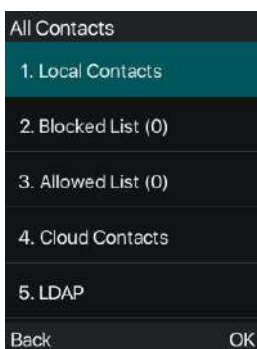

Picture 85 - Phone book screen

Note! Phone user account can store contact information, different models and specifications.

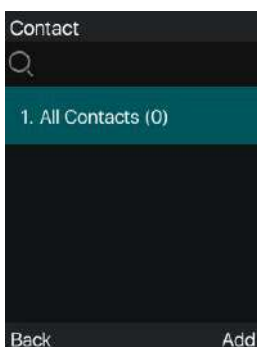

Picture 86 - Local Phone book

When there are contact records in the phone book, the contact records will be arranged in the alphabet order. User may browse the contacts with up/down navigator keys. The record indicator tells user which contact is currently focused. User may check the contact’s information by pressing **[OK]** button.

10.2.1.1 Add / Edit / Delete Contact

To add a new contact, user should press **[Add]** button to open Add Contact screen and enter the contact information of the followings,

- Contact Name
- Tel. Number
- Mobile Number
- Other Number
- Line
- Ring Tone
- Contact Group

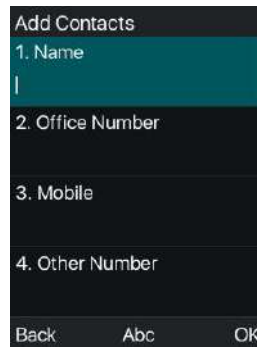

Picture 87 - Add New Contact

User can edit a contact by pressing **[Option]** >> **[Edit]** button.

To delete a contact, user should move the record indicator to the position of the contact to be deleted, press **[Option]** >> **[Delete]** button and confirm with **[OK]**.

10.2.1.2 Add / Edit / Delete Group

By default, the group list is blank. User can create his/her own groups, edit the group name, add or remove contacts in the group, and delete a group.

- To add a group, press **[Add Group]** button.
- To delete a group, press **[Option]** >> **[Delete]** button.
- To edit a group, press **[Edit]** button.

The Number behind the group name means the total contacts number of selected groups.

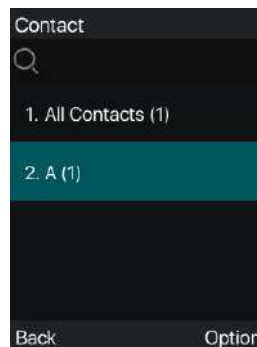

Picture 88 - Group List

10.2.1.3 Browse and Add / Remove Contacts in Group

User can browse contacts in a group by opening the group in group list with **[OK]** button.

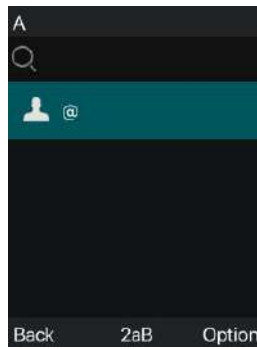

Picture 89 - Browsing Contacts in a Group

When user is browsing contacts of a group, user can also add contacts in that group by pressing **[Add]** button to enter the group contacts management interface, then press **[OK]** button to save the contact. The contact will also be added in local phonebook. User can delete contact from group by **[Option]** >> **[Delete]**.

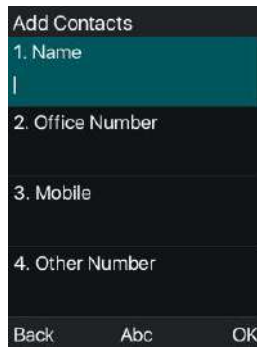

Picture 90 - Add Contacts in a Group

10.2.2 Blocked List

The device Support Blocked List, such as the number added to the Blocked List, the number of calls directly refused to the end, the end of the phone shows no incoming calls. (Blocked Listed Numbers can be called out normally)

- There are multiple ways to add a number to Blocked List on devices. It can be added directly on **[Menu]** >> **[Contact]** >> **[Blocked List]**.
- Select any number in the phone book (both local and network) for configuration addition.
- Select any number in the call log for configuration addition.

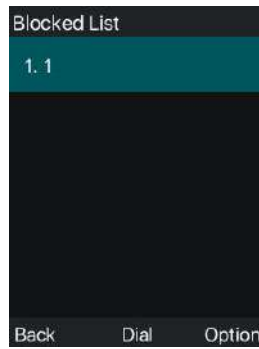

Picture 91 - Add Blocked List

- There are various ways to add number to the Blocked List on web page, which can be added in the [Contact] >> [Call list] >> [Restricted Incoming Calls].
- Select any number in the phone book (both local and network) for configuration addition.
- Select any number in the call log for configuration addition.

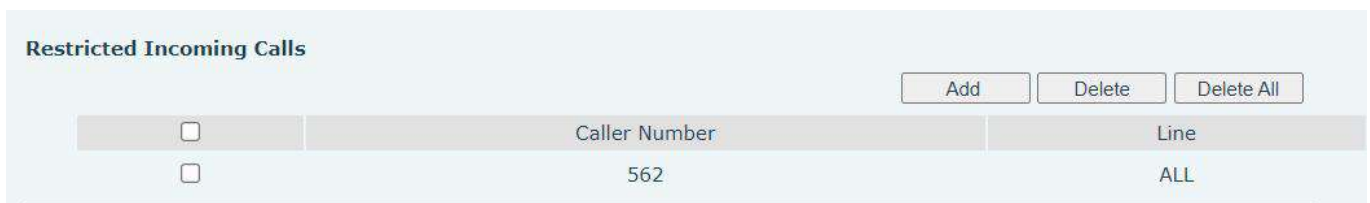

Picture 92 - Web Blocked List

10.2.3 Cloud Phone Book

10.2.3.1 Configure Cloud Phone book

Cloud phonebook allows user to configure the device by downloading a phonebook from a cloud server. This is convenient for office users to use the phonebook from a single source and save the effort to create and maintain the contact list individually. It is also a useful tool to synchronize his/her phonebook from a personal mobile phone to the device with Fanvil Cloud Phonebook Service and App which is to be provided publicly soon.

NOTICE! The cloud phonebook is ONLY temporarily downloaded to the device each time when it is opened on the device to ensure the user get the latest phonebook. However, the downloading may take a couple seconds depending on the network condition. Therefore, it is highly recommended for the users to save important contacts from cloud to local phonebook for saving download time.

Open cloud phonebook list, press [Menu] >> [Contact] >> [Cloud Contacts] in phonebook screen.

TIPS! The first configuration on cloud phone should be completed on Web page by selecting [PhoneBook] >> [Cloud Contacts]. The setting of addition/deletion on device could be done after the first setting on Web page.

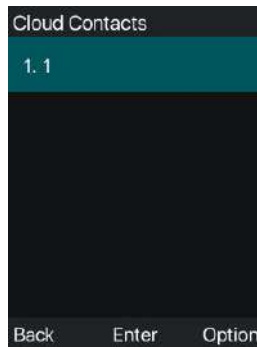

Picture 93 - Cloud phone book list

10.2.3.2 Downloading Cloud Phone book

In cloud phone book screen, user can open a cloud phone book by pressing [OK] / [Enter] button. The device will start downloading the phone book. The user will be prompted with a warning message if the download fails,

Once the cloud phone book is downloaded completely, the user can browse the contact list and dial the contact number same as in local phonebook.

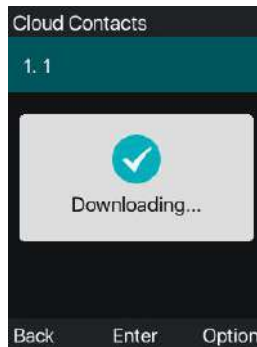

Picture 94 - Downloading Cloud Phone book



Picture 95 - Browse contacts in cloud phone book

10.3 Call Log

The phone can store the call record (the quantity of storage varies according to different specifications). The user can press **[Menu]>>[Call Log]>>[Local Call Logs]** to open the call record and check the records of all incoming calls, outgoing calls and missed calls.

In the call logs interface, user may browse the call logs with up/down navigator keys.

Each call log record is presented with 'call type' and 'call party number / name'. User can check further call log detail by pressing **[OK]** button and dial the number with **[Dial]** button, or add the call log number to phonebook with pressing **[Option] >> [Add to Contact]** .

User can delete a call log by pressing **[Delete]** button and clear all call logs by pressing **[Delete All]** button.



Picture 96 - Call Log

Users can also filter the call records of specific call types to narrow down the scope of search records, and select a call record type by left and right navigation keys.



- Missed Call Log



- Incoming Call Log



- Outgoing Call Log



- Forward Call Log

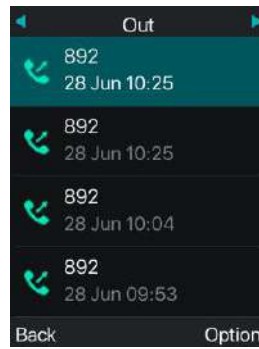

Picture 97 - Filter call record types

10.4 Function Key

Users can customize and configure the function keys on the side of the phone, and users can modify the settings of the corresponding keys by short/long press on the unconfigured shortcut keys.

Note: When the configuration key is configured as a function key type (such as PTT) triggered by a long press, and the health value is configured, you can go to [Menu] >> [Basic] >> [Keyboard] >> [DSS Key Settings] Or configure and change the value of the function key on the web page.

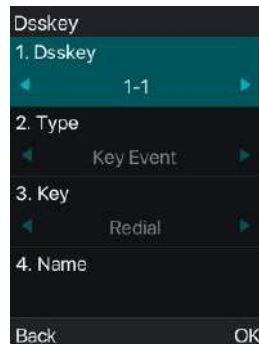

Picture 98 - DSS LCD key Page Configuration Screen

The DSS Key could be configured as followings,

- ◆ Memory Key
 - Speed Dial/Intercom/MWI/Call Forward (to someone)
- ◆ Line
- ◆ Key Event
 - MWI/DND/Hold/Transfer/Phonebook/Redial/Pickup/Call Forward (to specified line)/Headset/SMS/Release
- ◆ DTMF
- ◆ Action URL
- ◆ Multicast
- ◆ XML Browser

◆ PTT

Webpage interface: [Function key] >> [Side key].

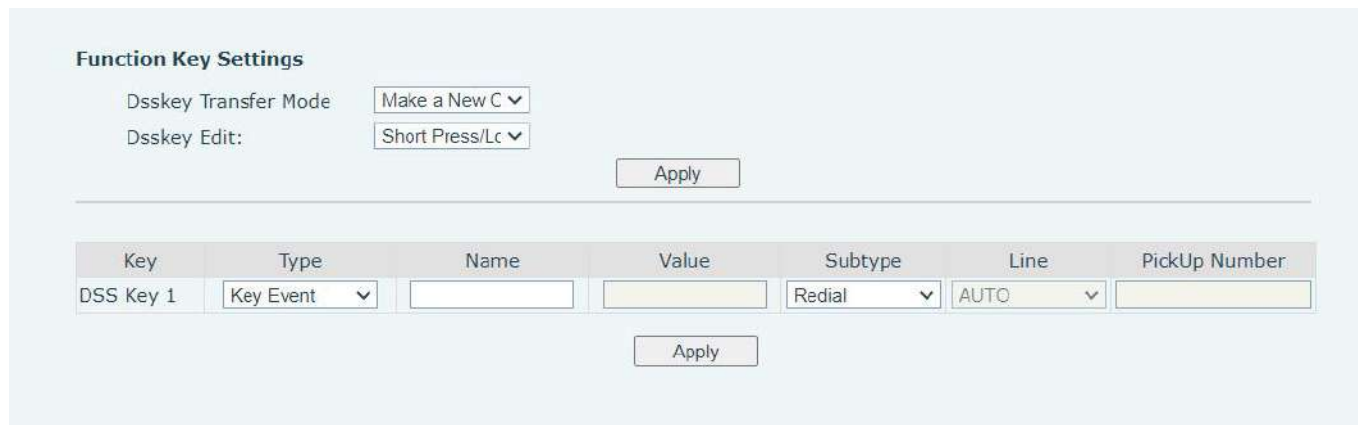

Picture 99 - DSS settings

Moreover, user also can add the user-defined title for the DSS Keys, which is configured as Memory Key / Line / URL / Multicast / Prefix.

More detailed information refers to [12.23 Function Key](#) and [6.3 Appendix III –LED](#) .

10.5 Wi-Fi

The device has built-in Wi-Fi and supports wireless Internet access. For more details, please refer to [7.4 Connecting to Wi-Fi](#).

10.6 Headset

10.6.1 Wired Headset

The device supports wired earphones with 3.5mm earphone jack, enabling the earphones to play incoming call prompts, earphone calls, etc.

After the phone is connected to the headset, the status bar displays the headset icon, indicating that the headset channel is available.

On the webpage [Phone settings] >> [Features], you can set the headset answering function, and the ring tone for headset.

Note: W611W enables these two configurations by default.



Picture 100 - Headset function settings

10.6.2 Bluetooth Headset

The device has a built-in Bluetooth 5.0 module

- Press soft-button **[Menu]** till you find the **[Basic]** item.
- Press **[Bluetooth]** to enter the setup interface.
- Select Bluetooth, and use the left and right keys to enable Bluetooth. Select Paired Device. If no paired is displayed, press **[Scan]** key to search and select the scanned device to connect.

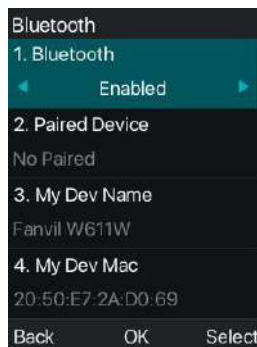

Picture 101 - Bluetooth Settings Screen

The use of Bluetooth headset can be divided into three types: call answering; Hang up; Bluetooth redial.

- call answering

When the Bluetooth headset is connected to the phone, the incoming call can be answered by pressing the Bluetooth answer button.
- Hang up
 - 1) When talking with Bluetooth headset, you can hang up the phone by pressing the button on Bluetooth headset.
 - 2) When there is an incoming call, double-click the answer button to reject the call.
 - 3) When the caller is in the ringing state, press the answer button of the headset to cancel the call.
- Bluetooth redial

When the Bluetooth headset is connected, double-click the answer button to redial the number dialed last time.

NOTICE! some models do not support double - click redial function. Whether this function is supported or not, you can check the instruction of the headset, or connect the Bluetooth headset to the phone, and double-click the answer button to see whether it will redial.

10.7 Advanced

10.7.1 Line Configurations

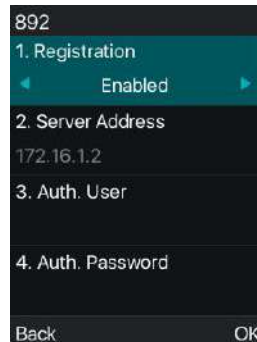

Picture 102 - SIP address and account information

Save the adjustment by pressing [OK] when done.

Users who want to configure more options should use web management portal to modify or System in accounts on the individual line to configure those options.

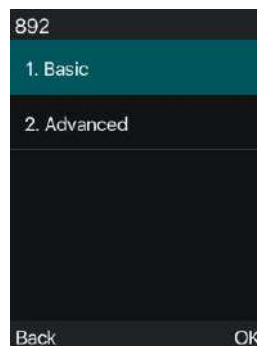

Picture 103 - Configure Advanced Line Options

10.7.2 Network Settings

10.7.2.1 Network Settings

■ **IP Mode**

There are 3 network protocol mode options, IPv4, IPv6 and IPv4 & IPv6.

Users can set it on the webpage [Network] >> [Basic]. Select Wi-Fi for the network type, and you can set the network mode.

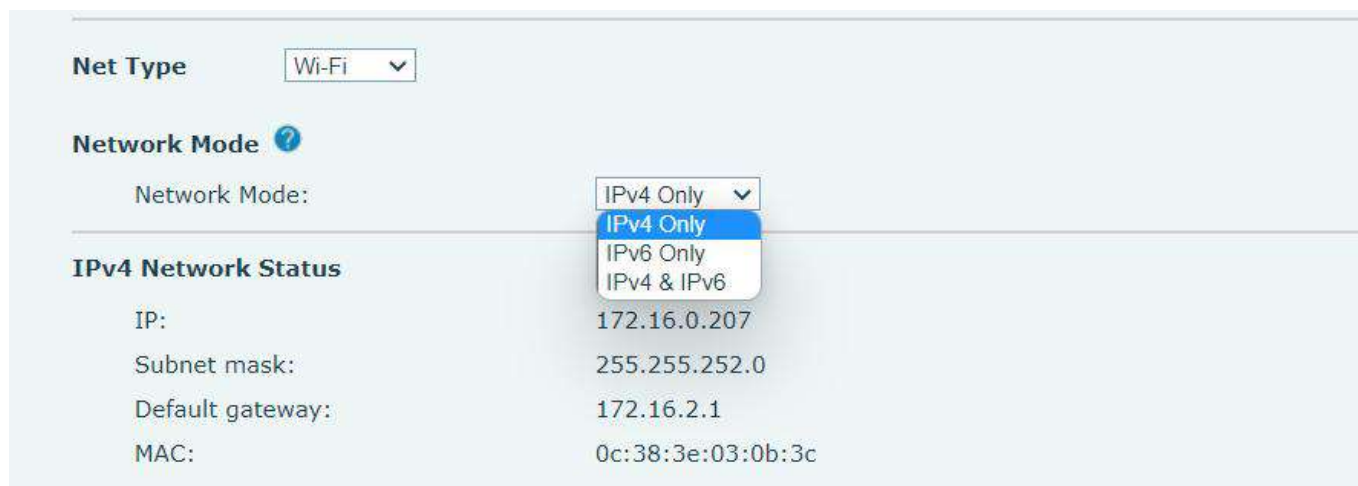

Picture 104 - Network mode Settings

■ **IPv4**

In IPv4 mode, there are 3 connection mode options: DHCP, PPPoE and Static IP.

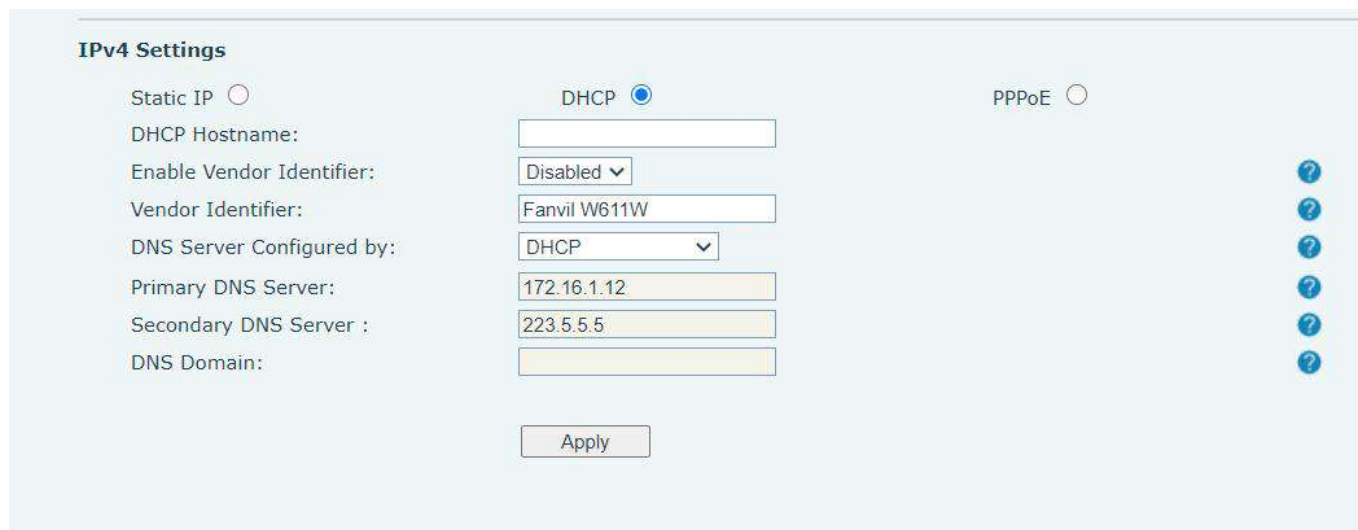

Picture 105 - DHCP network mode

When using DHCP mode, phone will get the IP address from DHCP server (router).

- Use DHCP DNS: It is enabled as default. “Enable” means phone will get DNS address from DHCP server and “disable” means not.
- Use DHCP time: It is disabled as default. “Enable” to manage the time of get DNS address from DHCP server and “disable” means not.

IPv4 Settings

Static IP DHCP PPPoE

PPPoE Username:

PPPoE Password:

Primary DNS Server:

Secondary DNS Server :

DNS Domain:

Picture 106 - PPPoE network mode

When using PPPoE, phone will get the IP address from PPPoE server.

- Username: PPPoE user name.
- Password: PPPoE password.

IPv4 Settings

Static IP DHCP PPPoE

IP:

Subnet mask:

Default gateway:

Primary DNS Server:

Secondary DNS Server :

DNS Domain:

Picture 107 - Static IP network mode

When using Static IP mode, user must configure the IP address manually.

- IP Address: Phone IP address.
- Mask: sub mask of your LAN.
- Gateway: The gateway IP address. Phone could access the other network via it.
- Primary DNS: Primary DNS address. The default is 8.8.8.8, Google DNS server address.
- Secondary DNS: When primary DNS is not available, Secondary DNS will work.

■ **IPv6**

In IPv6, there are 2 connection mode options, DHCP and Static IP.

- DHCP configuration refers to IPv4 introduction in last page.
- Static IP configuration is almost same as IPv4's, except the IPv6 Prefix.
- IPv6 Prefix: IPv6 prefix, it is similar with mask of IPv4.

The screenshot shows the 'IPv6 Settings' configuration page. At the top, 'Static IP' is selected with a radio button, and 'DHCP' is unselected. Below this, there are input fields for 'IP:', 'Prefix Length:', 'Default gateway:', 'Primary DNS Server:', 'Secondary DNS Server:', and 'DNS Domain:'. An 'Apply' button is located at the bottom center of the form.

Picture 108 - IPv6 Static IP network mode

10.7.2.2 VPN

Virtual Private Network (VPN) is a technology to allow device to create a tunneling connection to a server and becomes part of the server’s network. The network transmission of the device may be routed through the VPN server.

For some users, especially enterprise users, a VPN connection might be required to be established before activate a line registration. The device supports two VPN modes, Layer 2 Transportation Protocol (L2TP) and OpenVPN.

The VPN connection must be configured and started (or stopped) from the device web portal.

■ L2TP

NOTICE! The device only supports non-encrypted basic authentication and non-encrypted data tunneling. For users who need data encryption, please use OpenVPN instead.

To establish a L2TP connection, users should log in to the device web portal, open webpage [Network] >> [VPN]. In VPN Mode, check the “Enable VPN” option and select “L2TP”, then fill in the L2TP server address, Authentication Username, and Authentication Password in the L2TP section. Press “Apply” then the device will try to connect to the L2TP server.

When the VPN connection established, the VPN IP Address should be displayed in the VPN status. There may be the delay of the connection establishment. User may need to refresh the page to update the status.

Once the VPN is configured, the device will try to connect with the VPN automatically when the device

boots up every time until user disable it. Sometimes, if the VPN connection does not establish immediately, user may try to reboot the device and check if VPN connection established after reboot.

■ **OpenVPN**

To establish an OpenVPN connection, user should get the following authentication and configuration files from the OpenVPN hosting provider and name them as the following,

- OpenVPN Configuration file: client.ovpn
- CA Root Certification: ca.crt
- Client Certification: client.crt
- Client Key: client.key

User then upload these files to the device in the web page **[Network] >> [VPN]**, select OpenVPN Files. Then user should check “Enable VPN” and select “OpenVPN” in VPN Mode and click “Apply” to enable OpenVPN connection. Same as L2TP connection, the connection will be established every time when system rebooted until user disable it manually.

10.7.2.3 Web Server Type

Configure the Web Server mode to be HTTP or HTTPS and will be activated after the reboot. Then user could use http/https protocol to access pone web page. **[Menu] >> [Advanced] >> [Network] >> [Web Server Type]**

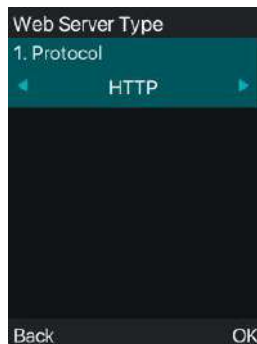

Picture 109 - The phone configures the web server type

10.7.3 Set The Secret Key

When the device is in the default standby mode,

- Select **[Menu] >> [Advanced]**, and enter it via [Confirm] or [OK] button.
- As default, the Advance setting password is 123. Select **[Security]** ,then user will see the follow page Security.

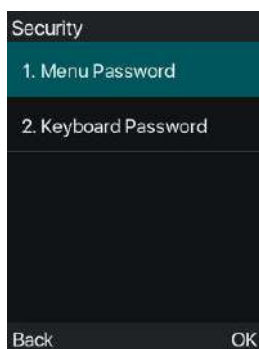

Picture 110 - Menu password

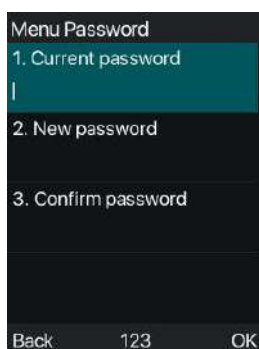

Picture 111 - Set menu password

Menu password is the permission for accessing the advanced setting.

- **[Current password]** is the password user configured before. If no configuration before, the default password is 123.
- **[New password]** is the new password user to use.
- After configuring the menu password, it will work immediately.

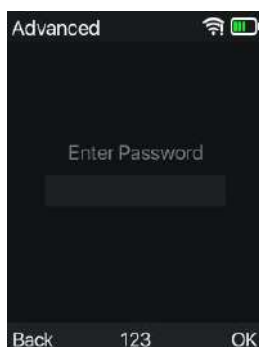

Picture 112 - Keyboard lock password

Keyboard password is used to unlock the phone once it's locked.

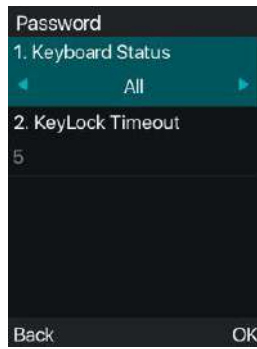

Picture 113 - Set keyboard lock password

User could only set to enable or disable the keyboard password in LCD screen.

- Enter [Keyboard password] setting by pressing [confirm] or [OK] button after password entered. If no menu password configuration before, it is 123 as default.
- If the menu password is correct, phone will go to keyboard password interface. As default, the keyboard password is disabled. When it is enabled, the keyboard will be locked after timeout.
- If user does not configure the keyboard lock time, (it is 0 as default). Long pressing “#” will lock the phone. There will be a lock icon in the top of LCD. Phone will reminder “Enter Password” after pressing any keys.

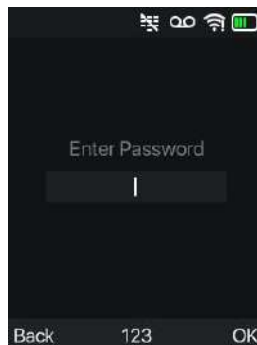

Picture 114 - Phone keypad lock password input interface

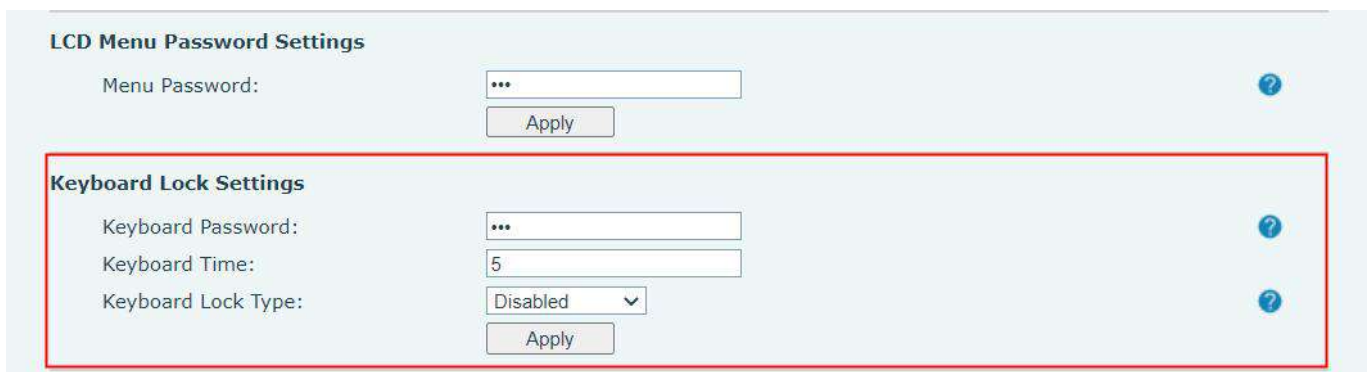

Picture 115 - Web keyboard lock password settings

10.7.4 Maintenance

Phone Webpage: Login and go to [System] >> [Auto provision].

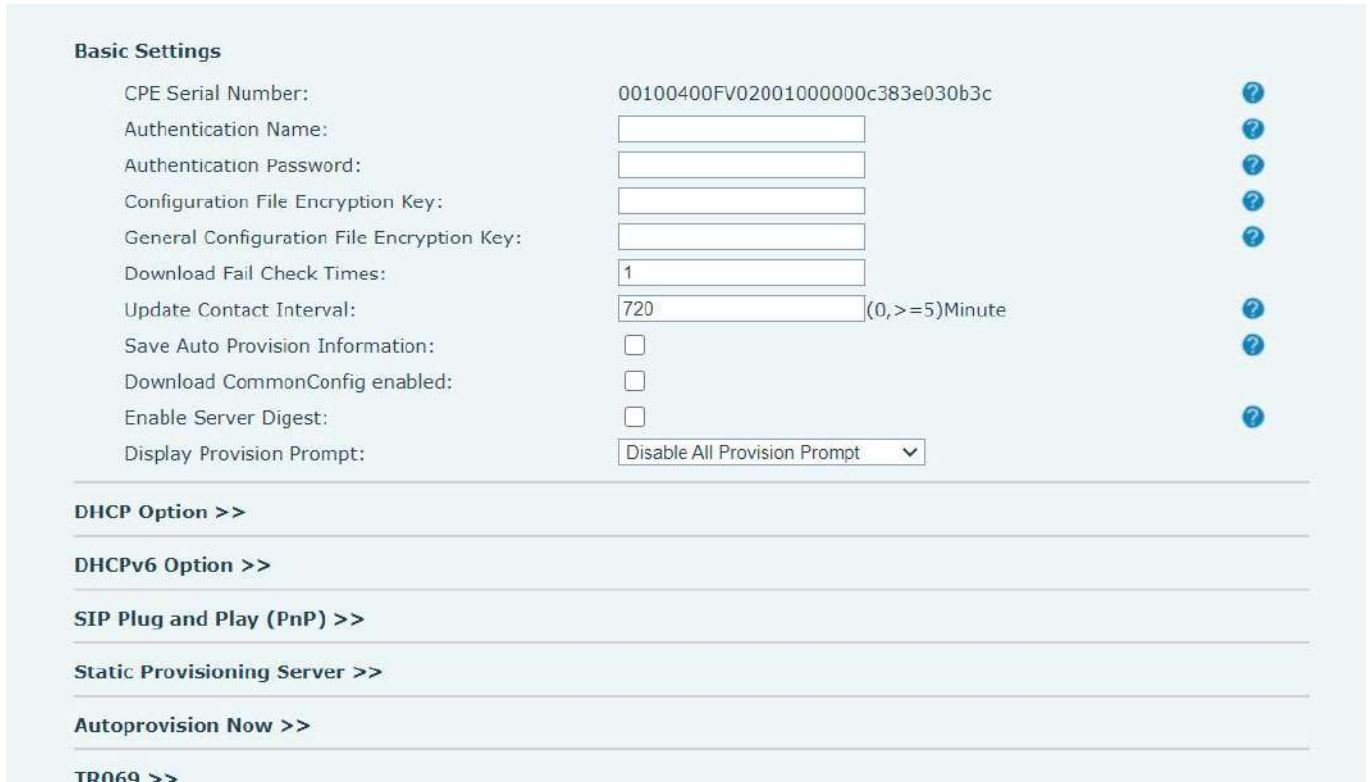

Picture 116 - Page auto provision Settings

LCD: [Menu] >> [Advanced] >> [Maintenance] >> [Auto Provision].

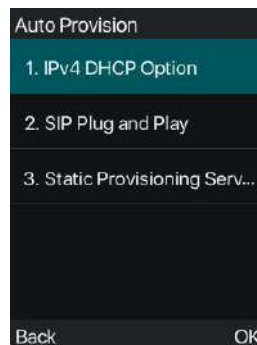

Picture 117 - Phone auto provision settings

Fanvil devices support SIP PnP, DHCP options, Static provision, TR069. If all of the 4 methods are enabled, the device will be upgraded according to the method obtained first.

Transferring protocol: FTP, TFTP, HTTP, HTTPS

This article only briefly introduces automatic deployment. For details, please refer to the document **Fanvil Auto Provision**.

Table 12 - Auto Provision

Parameters	Description
Basic settings	
CPE Serial Number	Display the device SN
Authentication Name	The user name of provision server
Authentication Password	The password of provision server
Configuration File Encryption Key	If the device configuration file is encrypted , user should add the encryption key here
General Configuration File Encryption Key	If the common configuration file is encrypted, user should add the encryption key here
Download Fail Check Times	If there download is failed, phone will retry with the configured times.
Update Contact Interval	Phone will update the phonebook with the configured interval time. If it is 0, the feature is disabled.
Save Auto Provision Information	Save the HTTP/HTTPS/FTP user name and password. If the provision URL is kept, the information will be kept.
Download Common Config enabled	Whether phone will download the common configuration file.
Enable Server Digest	When the feature is enable, if the configuration of server is changed, phone will download and update.
DHCP Option	
Option Value	Configre DHCP option, DHCP option supports DHCP custom option DHCP option 66 DHCP option 43, 3 methods to get the provision URL. The default is Option 66.
Custom Option Value	Custom Option value is allowed from 128 to 254. The option value must be same as server define.
Enable DHCP Option 120	Use Option120 to get the SIP server address from DHCP server.
SIP Plug and Play (PnP)	
Enable SIP PnP	Whether enable PnP or not. If PnP is enable, phone will send a SIP SUBSCRIBE message with broadcast method. Any server can support the feature will respond and send a Notify with URL to phone. Phone could get the configuration file with the URL.
Server Address	Broadcast address. As default, it is 224.0.0.0
Server Port	PnP port
Transport Protocol	PnP protocol, TCP or UDP.
Update Interval	PnP message interval.

Static Provisioning Server	
Server Address	Provisioning server address. Support both IP address and domain address.
Configuration File Name	The configuration file name. If it is empty, phone will request the common file and device file which is named as its MAC address. The file name could be a common name, \$mac.cfg, \$input.cfg. The file format supports CFG/TXT/XML.
Protocol Type	Transferring protocol type , supports FTP、TFTP、HTTP and HTTPS
Update Interval	Configuration file update interval time. As default it is 1, means phone will check the update every 1 hour.
Update Mode	Provision Mode. 1. Disabled. 2. Update after reboot. 3. Update after interval.
TR069	
Enable TR069	Enable TR069 after selection
ACS Server Type	There are 2 options Serve type, common and CTC.
ACS Server URL	ACS server address
ACS User	ACS server username (up to is 59 character)
ACS Password	ACS server password (up to is 59 character)
Enable TR069 Warning Tone	If TR069 is enabled, there will be a prompt tone when connecting.
TLS Version	TLS version (TLS 1.0, TLS 1.1, TLS 1.2)
INFORM Sending Period	INFORM signal interval time. It ranges from 1s to 999s
STUN Server Address	Configure STUN server address
STUN Enable	To enable STUN server for TR069

10.7.5 Firmware Upgrade

- Web page: Login phone web page, go to **[System]** >> **[Upgrade]**

Software upgrade ?

Current Software Version: T1.5.0

System Image File:

Upgrade Server

Enable Auto Upgrade:

Upgrade Server Address1:

Upgrade Server Address2:

Update Interval: Hour(s)

Firmware Information

Current Software Version: T1.5.0

Server Firmware Version:

New Firmware Information:

Ring Upgrade ?

Load Server File: (*.wav,*.tar.gz)

Picture 118 - Web page firmware upgrade

- LCD interface: go to [Menu] >> [Advanced setting] >> [Firmware Upgrade] .

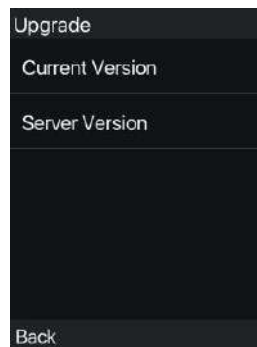

Picture 119 - Firmware upgrade information display

Table 13 - Firmware upgrade

Parameter	Description
Upgrade server	
Enable Auto Upgrade	Enable automatic upgrade, If there is a new version txt and new software firmware on the server, phone will show a prompt upgrade message after Update Interval.
Upgrade Server Address1	Set available upgrade server address.

Upgrade Server Address2	Set back up available upgrade server address.
Update Interval	Set Update Interval. Enable Auto Upgrade and configure the Update Interval. If the server has a new firmware, the phone will prompt for upgrade at the interval.
Firmware Information	
Current Software Version	It will show Current Software Version.
Server Firmware Version	It will show Server Firmware Version.
[Upgrade] button	If there is a new version txt and new software firmware on the server, the page will display version information and upgrade button will become available; Click [Upgrade] button to upgrade the new firmware.
New version description information	When there is a corresponding TXT file and version on the server side, the TXT and version information will be displayed under the new version description information.

- The file requested from the server is a TXT file called vendor_model_hw1_0.txt. Hw followed by the hardware version number, it will be written as hw1_0 if no difference on hardware. All Spaces in the filename are replaced by underline.
For example, the txt file name requested by X7C phone is linkvil_w611w_hwv1_0.txt
- The URL requested by the phone is HTTP:// server address/vendor_Model_hw10.txt: The new version and the requested file should be placed in the download directory of the HTTP server, as shown in the figure:



- TXT file format must be UTF-8
- vendor_model_hw10.TXT The file format is as follows:
Version=2.12.1 #Firmware
Firmware=xxx/xxx.z #URL, Relative paths are supported and absolute paths are possible, distinguished by the presence of protocol headers.
BuildTime=2022.05.06 20:00
Info=TXT

Xxxxx
Xxxxx
Xxxxx
Xxxxx

- After the update cycle interval time arrives, if the server has available files and versions, the phone will

prompt as shown below, click View to view the version information and upgrade.

10.7.6 Factory Reset

- 1) The phone is in default standby mode.
 - Press **[Menu]** to find **[System]**, and press **[OK]**.
 - Press **[System]** to enter the password (default password is 123) to enter the interface.
 - Press the **[Restore factory Settings]** button to select the file to be cleared.
 - Press **[OK]** to clear after completion. When you select clear configuration file and clear all, the phone will restart automatically after clearing.

- 2) In standby, press and hold the **[OK]** button for 6S to perform the reset operation

11 Web Configurations

11.1 Web Page Authentication

The user can log into the web page of the phone to manage the user's phone information and operate the phone. Users must provide the correct user name and password to log in.

11.2 System >> Information

User can get the system information of the device in this page including,

- Model
- Hardware Version
- Software Version
- Uptime
- Memory information
- System time

And summarization of network status,

- Network Mode
- Ethernet MAC
- Wi-Fi MAC
- Bluetooth MAC
- Ethernet IP
- Wi-Fi IP
- Subnet Mask
- Default Gateway

Besides, summarization of SIP account status,

- SIP User
- SIP account status (Registered / Unapplied / Trying / Timeout)

11.3 System >> Account

On this page the user can change the password for the login page.

Users with administrator rights can also add or delete users, manage users, and set permissions and passwords for new users.

11.4 System >> Configurations

On this page, users with administrator privileges can view, export, or import the phone configuration, or restore the phone to factory Settings.

■ Clear Configurations

Select the module in the configuration file to clear.

SIP: account configuration.

AUTOPROVISION: automatically upgrades the configuration

TR069:TR069 related configuration

MMI: MMI module, including authentication user information, web access protocol, etc.

DSS Key: DSS Key configuration

■ Clear Data Tables

Select the local data table to be cleared, all selected by default.

■ Reset Phone

The phone data will be cleared, including configuration and database tables.

11.5 System >> Upgrade

Upgrade the phone software version, customized ringtone, background, boot logo icon, etc, can also be upgraded to delete the file. Ring tone support “.wav” format.

11.6 System >> Auto Provision

The Auto Provision settings help IT manager or service provider to easily deploy and manage the devices in mass volume. For the detail of Auto Provision, please refer to this link [Auto Provision Description](#).

11.7 System >> Tools

Tools provided in this page help users to identify issues at trouble shooting. Please refer to [13 Trouble Shooting](#) for more detail.

11.8 System >> Reboot Phone

This page can restart the phone.

12 Network >> Basic

This page allows users to configure network connection types and parameters.

12.1 Network >> Wi-Fi Settings

The default network priority is WiFi

The current device supports coexistence of wifi and Ethernet, and users can log in to the web page with any network address for configuration

For example, WiFi access IP is 172.16.3.138 and Ethernet access IP is 172.16.7.116

Page login 172.16.7.116, 172.16.3.138 Any network address login page for configuration

The screenshot shows the 'Network Adapter' configuration page. At the top, there is a 'Network Adapter Priority' section with a list containing 'Wi-Fi' and 'Ethernet'. To the right of the list are up and down arrow buttons, and an 'Apply' button below. Below this is the 'Net Type' dropdown menu set to 'Wi-Fi'. The 'Network Mode' section has a 'Network Mode' dropdown set to 'IPv4 Only'. The 'IPv4 Network Status' section displays the following information:

IP:	172.16.3.138
Subnet mask:	255.255.252.0
Default gateway:	172.16.7.1
MAC:	08:e9:f6:11:0e:b8

Picture 120 - Network Priority

This page can turn on WiFi, add WiFi information, and view the wireless network list.

The screenshot shows the 'Wi-Fi Settings' page. The 'Wi-Fi Enable' checkbox is checked, with an 'Apply' button below it. The 'Wi-Fi Info Add' section contains the following fields:

- SSID: [Text Input]
- Secure Mode: [None]
- Encryption Type: [TKIP]
- Username: [Text Input]
- Password: [Text Input]

An 'Add' button is located below the password field. The 'Wi-Fi Info List' section contains a table with the following structure:

	SSID	Secure Mode	Encryption Type
<input type="checkbox"/>			

Buttons for 'Delete' and 'Modify' are located below the table.

Picture 121 - WiFi Settings

12.2 Network >> Service Port

This page provides settings for Web page login protocol, protocol port settings and RTP port.

Picture 122 - Service Port Settings

Table 14 - Service port

Parameter	Description
Web Server Type	Reboot to take effect after settings. Optionally, the web page login is HTTP/HTTPS.
Web Logon Timeout	Default as 15 minutes, the timeout will automatically exit the login page, need to login again.
Web auto login	After the timeout does not need to enter a user name password, will automatically login to the web page.
HTTP Port	The default is 80. If you want system security, you can set ports other than 80. Such as :8080, webpage login: HTTP://ip:8080
HTTPS Port	The default is 443, the same as the HTTP port.
RTP Port Range Start	The value range is 1025 to 65535. The value of RTP port starts from the initial value set. For each call, the value of voice and video port is added 2.
RTP Port Quantity	Number of calls.

12.3 Network >> VPN

Users can configure a VPN connection on this page. See [10.7.2.3 VPN](#) for more details.

12.4 Network >> Advanced

Advanced network Settings are typically configured by the IT administrator to improve the quality of the phone service. For configuration, query the [10.7 Advanced](#) Settings.

12.5 Line >> SIP

Configure the Line service configuration on this page.

Table 15 - Line configuration on the web page

Parameters	Description
Register Settings	
Line Status	Display the current line status at page loading. To get the up to date line status, user has to refresh the page manually.
Activate	Whether the service of the line is activated
Username	Enter the username of the service account.
Authentication User	Enter the authentication user of the service account
Display Name	Enter the display name to be sent in a call request.
Authentication Password	Enter the authentication password of the service account
Realm	Enter the SIP domain if requested by the service provider
Server Name	Input server name.
SIP Server 1	
Server Address	Enter the IP or FQDN address of the SIP server
Server Port	Enter the SIP server port, default is 5060
Transport Protocol	Set up the SIP transport line using TCP or UDP or TLS.
Registration Expiration	Set SIP expiration date.
SIP Server 2	
Server Address	Enter the IP or FQDN address of the SIP server
Server Port	Enter the SIP server port, default is 5060
Transport Protocol	Set up the SIP transport line using TCP or UDP or TLS.
Registration Expiration	Set SIP expiration date.
SIP Proxy Server Address	Enter the IP or FQDN address of the SIP proxy server.
Proxy Server Port	Enter the SIP proxy server port, default is 5060.
Proxy User	Enter the SIP proxy user.
Proxy Password	Enter the SIP proxy password.
Backup Proxy Server Address	Enter the IP or FQDN address of the backup proxy server.
Backup Proxy Server Port	Enter the backup proxy server port, default is 5060.
Basic Settings	
Enable Auto Answering	Enable auto-answering, the incoming calls will be answered automatically after the delay time
Auto Answering Delay	Set the delay for incoming call before the system automatically answered it

Call Forward Unconditional	Enable unconditional call forward, all incoming calls will be forwarded to the number specified in the next field
Call Forward Number for Unconditional	Set the number of unconditional call forward
Call Forward on Busy	Enable call forward on busy, when the phone is busy, any incoming call will be forwarded to the number specified in the next field.
Call Forward Number for Busy	Set the number of call forward on busy .
Call Forward on No Answer	Enable call forward on no answer, when an incoming call is not answered within the configured delay time, the call will be forwarded to the number specified in the next field.
Call Forward Number for No Answer	Set the number of call forward on no answer.
Call Forward Delay for No Answer	Set the delay time of not answered call before being forwarded.
Transfer Timeout	Set the timeout of call transfer process.
Conference Type	Set the type of call conference, Local=set up call conference by the device itself, maximum supports two remote parties, Server=set up call conference by dialing to a conference room on the server
Server Conference Number	Set the conference room number when conference type is set to be Server
Subscribe For Voice Message	Enable the device to subscribe a voice message waiting notification, if enabled, the device will receive notification from the server if there is voice message waiting on the server
Voice Message Number	Set the number for retrieving voice message
Voice Message Subscribe Period	Set the interval of voice message notification subscription
Enable Hotline	Enabling hotline configuration, the device will dial to the specific number immediately at audio channel opened by off-hook handset or turn on hands-free speaker or Headset
Hotline Delay	Set the delay for hotline before the system automatically dialed it
Hotline Number	Set the hotline dialing number
Dial Without Registered	Set call out by proxy without registration
Enable Missed Call Log	If enabled, the phone will save missed calls into the call history record.
DTMF Type	Set the DTMF type to be used for the line
DTMF SIP INFO Mode	Set the SIP INFO mode to send '*' and '#' or '10' and '11'

Request With Port	Whether the URI carries port number.
Enable DND	Enable Do-not-disturb, any incoming call to this line will be rejected automatically
Subscribe For Voice Message	Enable the device to subscribe a voice message waiting notification, if enabled, the device will receive notification from the server if there is voice message waiting on the server
Use VPN	Set the line to use VPN restrict route
Use STUN	Set the line to use STUN for NAT traversal
Enable Failback	Whether to switch to the primary server when it is available.
Failback Interval	A Register message is used to periodically detect the time interval for the availability of the main Proxy.
Signal Failback	Multiple proxy cases, whether to allow the invite/register request to also execute failback.
Signal Retry Counts	The number of attempts that the SIP Request considers proxy unavailable under multiple proxy scenarios.
Codecs Settings	Set the priority and availability of the codecs by adding or remove them from the list.
System	
Use Feature Code	When this setting is enabled, the features in this section will not be handled by the device itself but by the server instead. In order to control the enabling of the features, the device will send feature code to the server by dialing the number specified in each feature code field.
Enable DND	Set the feature code to dial to the server
Disable DND	Set the feature code to dial to the server
Enable Call Forward Unconditional	Set the feature code to dial to the server
Disable Call Forward Unconditional	Set the feature code to dial to the server
Enable Call Forward on Busy	Set the feature code to dial to the server
Disable Call Forward on Busy	Set the feature code to dial to the server
Enable Call Forward on No Answer	Set the feature code to dial to the server
Disable Call Forward on No Answer	Set the feature code to dial to the server
Enable Blocking	Set the feature code to dial to the server

Anonymous Call	
Disable Blocking Anonymous Call	Set the feature code to dial to the server
Call Waiting On Code	Set the feature code to dial to the server
Call Waiting Off Code	Set the feature code to dial to the server
Send Anonymous On Code	Set the feature code to dial to the server
Send Anonymous Off Code	Set the feature code to dial to the server
SIP Encryption	Enable SIP encryption such that SIP transmission will be encrypted
RTP Encryption	Enable RTP encryption such that RTP transmission will be encrypted
Enable Session Timer	Set the line to enable call ending by session timer refreshment. The call session will be ended if there is not new session timer event update received after the timeout period
Session Timeout	Set the session timer timeout period
Response Single Codec	If setting enabled, the device will use single codec in response to an incoming call request
Keep Alive Type	Set the line to use dummy UDP or SIP OPTION packet to keep NAT pinhole opened
Keep Alive Interval	Set the keep alive packet transmitting interval
Keep Authentication	Keep the authentication parameters from previous authentication
Blocking Anonymous Call	Reject any incoming call without presenting caller ID
User Agent	Set the user agent, the default is Model with Software Version.
Specific Server Type	Set the line to collaborate with specific server type
SIP Version	Set the SIP version
Anonymous Call Standard	Set the standard to be used for anonymous
Local Port	Set the local port
Ring Type	Set the ring tone type for the line
Enable user=phone	Sets user=phone in SIP messages.
Use Tel Call	Set use tel call
Auto TCP	Using TCP protocol to guarantee usability of transport for SIP messages above 1500 bytes
Enable Rport	Set the line to add rport in SIP headers
Enable PRACK	Set the line to support PRACK SIP message
DNS Mode	Select DNS mode, A, SRV, NAPTR
Enable Long Contact	Allow more parameters in contact field per RFC 3840

Enable Strict Proxy	Enables the use of strict routing. When the phone receives packets from the server, it will use the source IP address, not the address in via field.
Convert URI	Convert not digit and alphabet characters to %hh hex code
Use Quote in Display Name	Whether to add quote in display name, i.e. "Fanvil" vs Fanvil
Enable GRUU	Support Globally Routable User-Agent URI (GRUU)
Sync Clock Time	Time Sync with server
Enable Inactive Hold	With the post-call hold capture package enabled, you can see that in the INVITE package, SDP is inactive.
Caller ID Header	Set the Caller ID Header
Use 182 Response for Call waiting	Set the device to use 182 response code at call waiting response
Enable Feature Sync	Feature Sync with server
Enable SCA	Enable/Disable SCA (Shared Call Appearance)
CallPark Number	Set the CallPark number.
Server Expire	Set the timeout to use the server.
TLS Version	Choose TLS Version.
uaCSTA Number	Set uaCSTA Number.
Enable Click To Talk	With the use of special server, click to call out directly after enabling.
Flash mode	Chose Flash mode, normal or SIP info.
Flash Info Content-Type	Set the SIP info content type.
Flash Info Content-Body	Set the SIP info content body.
PickUp Number	Set the scramble number when the Pickup is enabled.
JoinCall Number	Set JoinCall Number.
Intercom Number	Set Intercom Number.
Unregister On Boot	Whether to enable logout function.
Enable MAC Header	When opening the registration, are IP package and user agent with MAC.
Enable Register MAC Header	When opening the registration, is user agent with MAC.
BLF Dialog Strict Match	Whether to enable accurate matching of BLF sessions.
PTime(ms)	Set whether to bring ptime field, default no.
SIP Global Settings	
Strict Branch	Set up to strictly match the Branch field.
Enable Group	Set open group.
Enable RFC4475	Set to enable RFC4475.
Enable Strict UA Match	Enable strict UA matching.

Registration Failure Retry Time	Set the registration failure retry time.
Local SIP Port	Modify the phone SIP port.
Enable uaCSTA	Enable uaCSTA

12.6 Line >> SIP Hotspot

Please refer to [9.6 SIP Hotspot](#)

12.7 Line >> Dial Plan

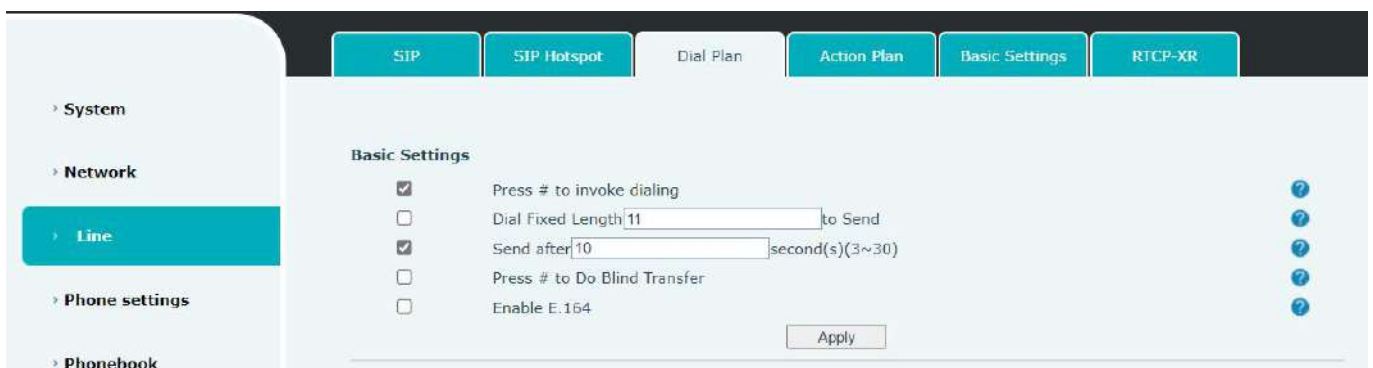

Picture 123 - Dial plan settings

Table 16 - Phone 7 dialing methods

Parameters	Description
Press # to invoke dialing	The user dials the other party's number and then adds the # number to dial out;
Dial Fixed Length	The number entered by the user is automatically dialed out when it reaches a fixed length
Timeout dial	The system dials automatically after timeout
Enable E.164	Please refer to E. 164 standard specification

Add dialing rules:

Picture 124 - Custom setting of dial - up rules

Table 17 - Dial - up rule configuration table

Parameters	Description
Dial rule	<p>There are two types of matching: Full Matching or Prefix Matching. In Full matching, the entire phone number is entered and then mapped per the Dial Peer rules.</p> <p>In prefix matching, only part of the number is entered followed by T. The mapping with then take place whenever these digits are dialed. Prefix mode supports a maximum of 30 digits.</p>
<p>Note: Two different special characters are used.</p> <ul style="list-style-type: none"> ■ x -- Matches any single digit that is dialed. ■ [] -- Specifies a range of numbers to be matched. It may be a range, a list of ranges separated by commas, or a list of digits. 	
Destination	Set Destination address. This is for IP direct.
Port	Set the Signal port, and the default is 5060 for SIP.
Alias	Set the Alias. This is the text to be added, replaced or deleted. It is an optional item.
<p>Note: There are four types of aliases.</p> <ul style="list-style-type: none"> ■ all: xxx – xxx will replace the phone number. ■ add: xxx – xxx will be dialed before any phone number. ■ del: The characters will be deleted from the phone number. 	

<p>■ rep: xxx – xxx will be substituted for the specified characters.</p>	
Suffix	Characters to be added at the end of the phone number. It is an optional item.
Length	Set the number of characters to be deleted. For example, if this is set to 3, the phone will delete the first 3 digits of the phone number. It is an optional item.

For Example

This feature allows the user to create rules to make dialing easier. There are several different options for dial rules. The examples below will show how this can be used.

Example 1: All Substitution -- Assume that it can make a direct IP call to IP address 172.168.2.208. Using this feature, 123 can be substituted for 172.168.2.208.

Index	Digit Map	Call	Match to Send	Line	Alias Type: Number(length)	Suffix	Media
1	"123"	Out	No	SIP DIALPEER(172.16.1.15:5560)			Default

Picture 125 - Dial rules table (1)

Example 2: Partial Substitution -- To dial a long distance call to Beijing requires dialing area code 010 before the local phone number. Using this feature 1 can be substituted for 010. For example, to call 62213123 would only require dialing 162213123 instead of 01062213123.

Index	Digit Map	Call	Match to Send	Line	Alias Type: Number(length)	Suffix	Media
1	"1T"	Out	No	Fanvil@SIP1	rep:010(1)		Default

Picture 126 - Dial rules table (2)

Example 3: Addition -- Two examples are shown. In the first case, it is assumed that 0 must be dialed before any 11 digit number beginning with 13. In the second case, it is assumed that 0 must be dialed before any 11 digit number beginning with 135, 136, 137, 138, or 139.

Two different special characters are used:

x -- Matches any single digit that is dialed.

[] -- Specifies a range of numbers to be matched. It may be a range, a list of ranges separated by commas, or a list of digits.

12.8 Line >> Action Plan

Action Plan application: a technical implementation defined and designed by Fanvil for remote control and behavior linkage between Fanvil terminal equipment and other equipment. That is, when an event occurs on the Fanvil terminal, the terminal can perform an action, and this action is completed according to a Plan rule.

Log in to the phone web page, access [Line] -> [Action Plan], and configure the linkage plan rules.

Picture 127 - Action Plan

Table 18 - Action Plan

Parameter	Description
Action	<p>Default: when the rule is triggered, the phone displays video or converts multicast according to the RTSP URL or multicast address port set by the website.</p> <p>Video: when the rule is triggered, the phone accesses the RTSP URL configured by the URL to display the video.</p> <p>MCAST-XFER: when the rule is triggered, the phone converts the incoming call or multicast into multicast and sends it to the set multicast address port.</p> <p>Record: the phone automatically turns on the recording function when the rule is triggered.</p> <p>Mute: the phone will mute automatically when the rule is triggered.</p> <p>Answer: when the rule is triggered, the phone automatically answers the incoming call.</p>
Number	Auxiliary phone number
Type	Early: trigger execution before call

	establishment. Connected: trigger execution after call establishment.
Direction	For call mode, incoming/outgoing call
Line	Set up outgoing lines.
Username	Bind the user name of the IP camera.
Password	Bind IP camera password.
URL	Video streaming information or MCAST IP address.
User Agent	Set user agent information

12.9 Line >> Basic Settings

Set up the register global configuration.

Table 19 - Set the line global configuration on the web page

Parameters	Description
STUN Settings	
Server Address	Set the STUN server address
Server Port	Set the STUN server port, default is 3478
Binding Period	Set the STUN binding period which can be used to keep the NAT pinhole opened.
SIP Waiting Time	Set the timeout of STUN binding before sending SIP messages
The TLS authentication	
TLS Certification File	Upload or delete the TLS certification file used for encrypted SIP transmission.

12.10 Line >> RTCP-XR

RTCP-XR mode is based on RFC3611 (RTP Control Extended Report), which can measure and evaluate network packet loss, delay and voice quality by sending RTCP-XR packets.

Table 20 - VQ RTCP-XR Settings

Parameters	Description
VQ RTCP-XR Settings	
VQ RTCP-XR Session Report	VQ report on whether session mode is enabled or not.
VQ RTCP-XR Interval Report	Whether to turn on Interval mode for VQ report sending.

Period for Interval Report(5~99)	The time interval at which VQ reports are sent periodically.
Warning threshold for Moslq(15~40)	When the phone calculated the Moslq value x10 below the set threshold, a warning was issued.
Critical threshold for Moslq(15~40)	When the phone calculates the Moslq value x10 below the set threshold, the critical report is issued.
Warning Threshold for Delay(10~2000)	When the one-way delay of the phone is greater than the set threshold, warning is issued.
Critical Threshold for Delay(10~2000)	When the phone computes that the one-way delay is greater than the set threshold, the critical report is issued.
Display Report Options on Phone	Whether to display the VQ report data of the last call on the phone
Display Report Options on web	Whether to display the VQ report data for the last call through the web page.

12.11 Phone settings >> Features

Configuration phone features.

Table 21 - General function Settings

Parameters	Description
Basic Settings	
Enable Call Waiting	Enable this setting to allow user to take second incoming call during an established call. Default enabled.
Enable Call Transfer	Enable Call Transfer.
Semi-Attended Transfer	Enable Semi-Attended Transfer by selecting it
Enable 3-Way Conference	Enable 3-way conference by selecting it
Enable Auto Onhook	The phone will hang up and return to the idle automatically at hands-free mode
Auto Onhook Time	Specify Auto Onhook time, the phone will hang up and return to the idle automatically after Auto Hand down time at hands-free mode, and play dial tone Auto Onhook time at handset mode
Ring for Headset	Enable Ring for Handset by selecting it, the phone plays ring tone from handset.
Auto Headset	Enable this feature, headset plugged in the phone, user press 'answer' key to answer a call with the headset automatically.
Enable Silent Mode	When enabled, the phone is muted, there is no ringing when calls, you can use the volume keys and mute key to unmute.
Disable Mute for Ring	When it is enabled, you can't mute the phone

Enable Default Line	If enabled, user can assign default SIP line for dialing out rather than SIP1.
Enable Auto Switch Line	Enable phone to select an available SIP line as default automatically
Default Ext Line	Select the default line to use for outgoing calls
Ban Outgoing	If you select Ban Outgoing to enable it, and you cannot dial out any number.
Hide DTMF	Configure the hide DTMF mode.
Enable CallLog	Select whether to save the call log.
Enable Restricted Incoming List	Whether to enable restricted call list.
Enable Allowed Incoming List	Whether to enable the allowed call list.
Enable Restricted Outgoing List	Whether to enable the restricted allocation list.
Enable Country Code	Whether the country code is enabled.
Country Code	Fill in the country code.
Area Code	Fill in the area code.
Enable Number Privacy	Whether to enable number privacy.
Match Direction	Matching direction, there are two kinds of rules from right to left and from left to right.
Start Position	Open number privacy after the start of the hidden location.
Hide Digits	Turn on number privacy to hide the number of digits.
Allow IP Call	If enabled, user can dial out with IP address
P2P IP Prefix	Prefix a point-to-point IP call.
Caller Name Priority	Change caller ID display priority.
Emergency Call Number	Set Emergency Call Number
Search path	Select the search path.
LDAP Search	Select from with one LDAP for search
Emergency Call Number	Configure the Emergency Call Number. Despite the keyboard is locked, you can dial the emergency call number
Restrict Active URI Source IP	Set the device to accept Active URI command from specific IP address.
Push XML Server	Configure the Push XML Server, when phone receives request, it will determine whether to display corresponding content on the phone which sent by the specified server or not.
Enable Pre-Dial	Disable this feature, user enter number will open audio channel automatically.

	Enable the feature, user enter the number without opening audio channel.
Enable Multi Line	If enabled, up to 10 simultaneous calls can exist on the phone, and if disabled, up to 2 simultaneous calls can exist on the phone.
Line Display Format	Custom line format: SIPn/SIPn: xxx/xxx@SIPn
Contact As White List Type	NONE/BOTH/DND White List/FWD White List
Block XML When Call	Disable XML push on call.
SIP notify	When enabled, the phone displays the information when it receives the relevant notify content.
Tone Settings	
Enable Holding Tone	When turned on, a tone plays when the call is held
Enable Call Waiting Tone	When turned on, a tone plays when call waiting
Play Dialing DTMF Tone	Play DTMF tone on the device when user pressed a phone digits at dialing, default enabled.
Play Talking DTMF Tone	Play DTMF tone on the device when user pressed a phone digits during taking, default enabled.
DND Settings	
DND Option	Select to take effect on the line or on the phone or close.
Enable DND Timer	Enable DND Timer, If enabled, the DND is automatically turned on from the start time to the off time.
DND Start Time	Set DND Start Time
DND End Time	Set DND End Time
Intercom Settings	
Enable Intercom	When intercom is enabled, the device will accept the incoming call request with a SIP header of Alert-Info instruction to automatically answer the call after specific delay.
Enable Intercom Mute	Enable mute mode during the intercom call
Enable Intercom Tone	If the incoming call is intercom call, the phone plays the intercom tone
Enable Intercom Barge	Enable Intercom Barge by selecting it, the phone auto answers the intercom call during a call. If the current call is intercom call, the phone will reject the second intercom call
Response Code Settings	
DND Response Code	Set the SIP response code on call rejection on DND
Busy Response Code	Set the SIP response code on line busy
Reject Response Code	Set the SIP response code on call rejection
Password Dial Settings	
Enable Password Dial	Enable Password Dial by selecting it, When number entered is beginning with the password prefix, the following N numbers after the password

	prefix will be hidden as *, N stand for the value which you enter in the Password Length field. For example: you set the password prefix is 3, enter the Password Length is 2, then you enter the number 34567, it will display 3**67 on the phone.
Encryption Number Length	Configure the Encryption Number length
Password Dial Prefix	Configure the prefix of the password call number
Power LED	
Common	Standby power lamp state, off when off, open is always bright red. Off by default.
SMS/MWI	The status of power lamp when there is unread short message/voice message, including off/on/slow flash/quick flash, default slow flash.
Missed	The state of the power lamp when there is a missed call, including off/on/slow flash/quick flash, the default slow flash.
Talk/Dial	In the talk/dial state, the power lamp state, off is off, on is always red bright, the default is off.
Ringing	Power lamp status when there is an incoming call, including off/on/slow flash/quick flash, default flash.
Mute	Power lamp status in mute mode, including off/on/slow flash/quick flash, off by default.
Hold/Held	The power lamp state, including off/on/slow flash/quick flash, is turned off by default when left/retained.
Notification Popups	
Display Missed Call Popup	No incoming call popup prompt after opening, no popup prompt when closing, open by default.
Display MWI Popup	Voice message popup prompt is not answered after opening, and it is opened by default if there is no popup prompt when closing.
Display Device Connect Popup	There is a popup prompt when the WIFI adapter is connected. There is no popup prompt when the WIFI adapter is closed. It is on by default.
Display SMS Popup	There is popup prompt for unread messages after opening, and there is no popup prompt when closing. It is opened by default.
Display Other Popup	When the handle is not hung back after opening, registration fails, IP acquisition fails, Tr069 connection fails and other abnormalities, there will be popup prompt when it is opened; otherwise, there will be no prompt when it is closed, and it will be opened by default.

12.12 Phone settings >> Media Settings

Change voice Settings.

Table 22 - Voice settings

Parameters	Description
Codecs Settings	Select enable or disable voice encoding: G.711A/U,G.722,G.729, G.726-16,G726-24,G726-32,G.726-40, ILBC, Opus
Audio Settings	
Handset Volume	Set the Handset volume, the value must be 1~9
Default Ring Type	Configure default ringtones. If no special ringtone is set for the phone number, the default ringtone will be used.
Speakerphone Volume	Set the hands-free volume to 1-9.
Headset Ring Volume	Set the volume of the Headset ringtone to 1~9.
Headset Volume	Set the volume of the headset to 1~9.
Speakerphone Ring Volume	Set the volume of hands-free ringtone to 1~9.
G.723.1 Bit Rate	5.3kb/s or 6.3kb/s is available.
DTMF Payload Type	Enter the DTMF payload type, the value must be 96~127.
AMR Payload Type	Set AMR load type, range 96~127.
Headset Mic Gain	Set the Headset's radio volume gain to fit different models of Headsets.
Opus payload type	Set Opus load type, range 96~127.
OPUS Sample Rate	Set Opus sampling rate, including opus-nb (8KHz) and opus-wb (16KHz).
ILBC Payload Type	Set the ILBC Payload Type, the value must be 96~127.
ILBC Payload Length	Set the ILBC Payload Length
Enable MWI Tone	When there is a new voice message message, the phone will start a special dial tone.
Enable VAD	Whether voice activity detection is enabled.
Onhook Time	Configure a minimum response time, which defaults to 200ms
EHS Type	EHS headset is available after enabling.
RTP Control Protocol(RTCP) Settings	
CNAME user	Set CNAME user
CNAME host	Set CNAME host
RTP Settings	
RTP keep alive	Hold the call and send the packet after 30s
Alert Info Ring Settings	
Value	Set the value to specify the ring type.

Ring Type	Type1-Type9
-----------	-------------

12.13 Phone settings >> MCAST

This feature allows user to make some kind of broadcast call to people who are in multicast group. User can configure a multicast DSS Key on the phone, which allows user to send a Real Time Transport Protocol (RTP) stream to the pre-configured multicast address without involving SIP signaling. You can also configure the phone to receive an RTP stream from pre-configured multicast listening address without involving SIP signaling. You can specify up to 10 multicast listening addresses.

Table 23 - Multicast parameters

Parameters	Description
Normal Call Priority	Define the priority of the active call, 1 is the highest priority, 10 is the lowest.
Enable Page Priority	The voice call in progress shall take precedence over all incoming paging calls.
Name	Listened multicast server name
Host: port	Listened multicast server's multicast IP address and port.

12.14 Phone settings >> Action

Action URL

Action urls are used for IPPBX systems to submit phone events.

12.15 Phone settings >> Time/Date

The user can configure the time Settings of the phone on this page.

Table 24 - Time&Date settings

Parameters	Description
Network Time Server Settings	
Time Synchronized via SNTP	Enable time-sync through SNTP protocol
Time Synchronized via DHCP	Enable time-sync through DHCP protocol
Primary Time Server	Set primary time server address
Secondary Time Server	Set secondary time server address, when primary server is not reachable, the device will try to connect to secondary time server to get time synchronization.
Time Zone	Select the time zone
Resync Period	Time of re-synchronization with time server

12-Hour Clock	Set the time display in 12-hour mode
Date Format	Select the time/date display format
Daylight Saving Time Settings	
Local	Choose your local, phone will set daylight saving time automatically based on the local
DST Set Type	Choose DST Set Type, if Manual, you need to set the start time and end time.
Fixed Type	Daylight saving time rules are based on specific dates or relative rule dates for conversion. Display in read-only mode in automatic mode.
Offset	The offset minutes when DST started
Month Start	The DST start month
Week Start	The DST start week
Weekday Start	The DST start weekday
Hour Start	The DST start hour
Minute Start	The DST start minute
Month End	The DST end month
Week End	The DST end week
Weekday End	The DST end weekday
Hour End	The DST end hour
Minute End	The DST end minute
Manual Time Settings	You can set your time manually

12.16 Phone settings >> Time Plan

Time Plan (time management) settings can set a time point or a time period. The time point is to perform an action at a certain time, and the time period is to perform an action for a certain period of time.

Time Plan:

Name:

Type:

Repetition period:

Monthly: 1
 2
 3
 4
 5
 6
 7
 8
 9
 10

Effective time: : - :

Time Plan List:

<input type="checkbox"/> Index	Name	Type	Special configure	Repetition period	Effective time
<input type="button" value="Delete"/>					

Picture 127 - Time Plan (1)

Table 25 - Time Plan

configure	Value	Description
Time plan Type	1: Timed reboot 2: Timed upgrade 3: Timed forward 4: Timed config	Type, Action performed at a time point/time period
Repetition period Repetition period	0: No repetition 1: Daily 2: Weekly 3: Monthly	repeat type
in weeks	0-6 : Sunday-Saturday, supports multiple separated by ";" 1-31: 1-31 day	When the repetition type is daily/non-repeating, the value is empty
in days	xx:xx-xx:xx	start time - end time period

When the Time Plan type is selected as timed forwarding, the webpage will prompt to enter the forwarding number and forwarding line, as shown in the figure.

Time Plan:

Name:

Type:

Forward Number:

Line:

Repetition period:

Monthly: 6
 7
 8
 9
 10
 11
 12
 13
 14
 15

Effective time: : - :

Picture 129 - Time Plan (2)

Forwarding Number: Configure the forwarding number to forward to the number within the set time period.

Line: Forward the specified line, when the line is set to a certain line, it will only take effect for this line.

1. Timed forwarding rules:

1) When there is forwarding under the line, the forwarding number under the line is used; when there is no forwarding number under the SIP line, when there is an incoming call within the time period set by the scheduled forwarding, the phone will be forwarded to the specified scheduled forwarding number; when outside the time period, no forwarding is performed. That is, the priority Line>Time Plan.

2) All scheduled forwarding types are unconditional forwarding.

12.16.1 Repeat Period Select Daily

Select daily as the repetition period, and enter any time in the date format from 00:00 to 23:59 in the effective time input box.

The first and third input boxes only allow input of any integer from 00 to 23, and 0 is automatically added before inputting an integer less than 10.

The second and fourth input boxes only allow input of any integer from 00 to 59, and 0 is automatically added before inputting an integer less than 10.

Repetition period: Daily ▾

Effective time: 0 ▾ : 0 ▾ - 0 ▾ : 0 ▾

Add

Picture 130 - Time Plan (3)

12.16.2 Repeat Period Select Weekly

Day of the week selection box, check it to take effect.

The final effective time is the combination of the day of the week and the set time.

Repetition period: Weekly ▾

Weekly:

- Sunday
- Monday
- Tuesday
- Wednesday
- Thursday
- Friday
- Saturday

Effective time: 0 ▾ : 0 ▾ - 0 ▾ : 0 ▾

Add

Picture 131 - Time Plan (4)

12.16.3 Time Plan List

All configurations submitted after the configuration is submitted are displayed in a list, and the order is sorted by week (day, Monday, Tuesday...), and if the week is the same, it is sorted by time (time from small to large). The function sequence is restarted first and then upgraded.

Time Plan List: ?

<input type="checkbox"/>	Index	Name	Type	Special configure	Repetition period	Effective time
<input type="button" value="Delete"/>						

Picture 132 - Time Plan (5)

12.16.4 Delete

Check the box before the serial number, click to select all configuration items in the list.

Click Delete to delete the checked configuration in the configuration list, and it will become invalid after deletion.

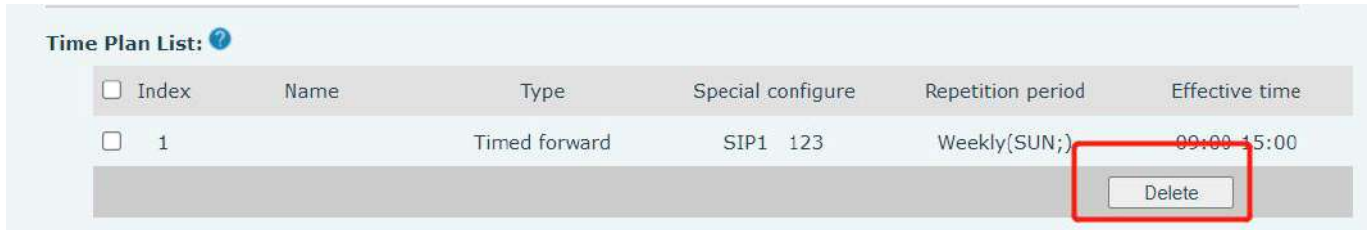

Picture 133 - Time Plan (6)

12.17 Phone settings >> Tone

This page allows users to configure a phone prompt.

You can either select the country area or customize the area. If the area is selected, it will bring out the following information directly. If you choose to customize the area, you can modify the button tone, call back tone and other information.

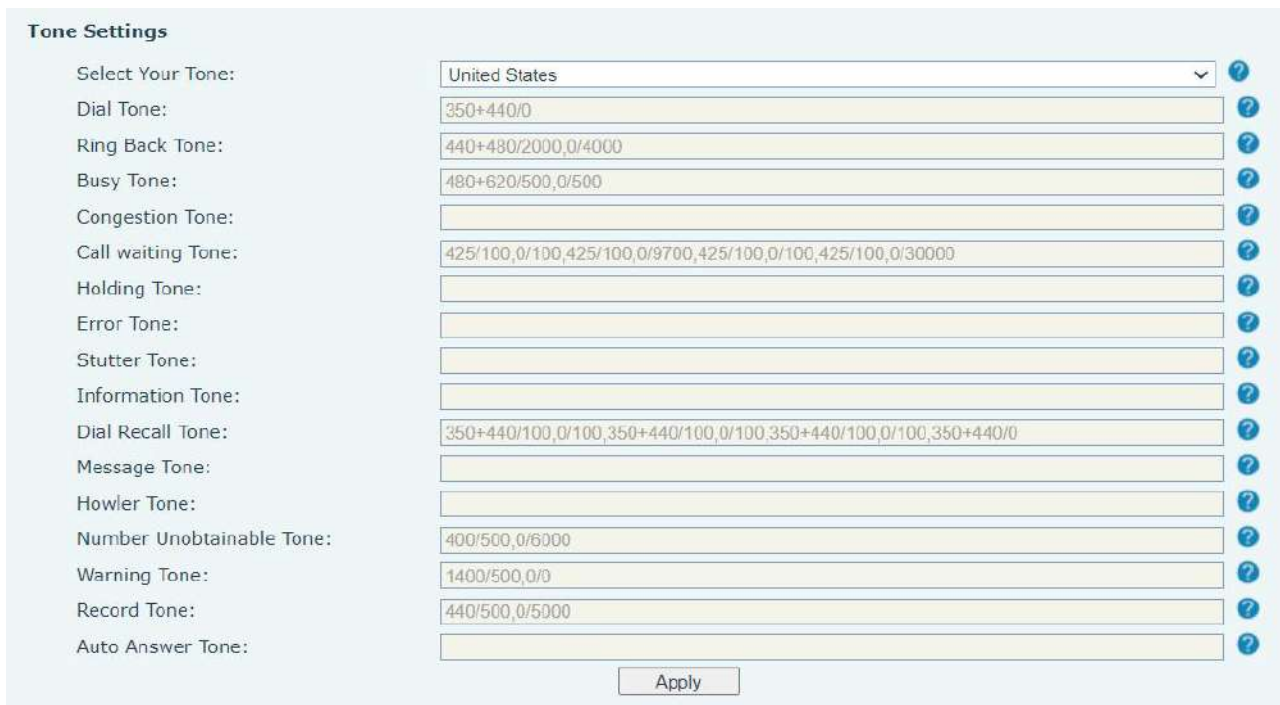

Picture 134 - Tone settings on the web

12.18 Phone settings >> Advanced

User can configure the advanced configuration settings in this page.

- Screen Configuration.
 - Enable Energy Saving

- Backlight Time
- UI Preference
 - Set font, color, and screensaver display
- LCD Menu Password Settings.
 - The password is 123 by default.
- Keyboard Lock Settings.
- Configure Greeting Words
 - The greeting message will display on the top left corner of the LCD when the device is idle, which is limited to 16 characters. The default chars are 'VOIP PHONE'.

12.19 Phonebook >> Contact

User can add, delete, or edit contacts in the phonebook in this page. User can browse the phonebook and sorting it by name, phones, or filter them out by group.

To add a new contact, user should enter contact's information and press "Add" button to add it.

To edit a contact, click on the checkbox in front of the contact, the contact information will be copied to the contact edit boxes, press "Modify" button after finished editing.

To delete one or multiple contacts, check on the checkbox in front of the contacts wished to be deleted and click the "Delete" button, or click the "Clear" button with selecting any contacts to clear the phonebook.

User can also add multiple contacts into a group by selecting the group in the dropdown options in front of "Add to Group" button at the bottom of the contact list, selecting contacts with checkbox and click "Add to Group" to add selected contacts into the group.

Similarly, user can select multiple users and add them into Blocked List by click "Add to Blocked List" button.

12.20 Phonebook >> Cloud phonebook

Cloud Phonebook

User can configure up to 4 cloud phonebooks. Each cloud phonebook must be configured with an URL where an XML phonebook is stored. The URL may be based on HTTP/HTTPS or FTP protocol with or without authentication. If authentication is required, user must configure the username and password.

To configure a cloud phonebook, the following information should be entered,

- Phonebook name (must)
- Phonebook URL (must)
- Access username (optional)
- Access password (optional)

LDAP Settings

The cloud phonebook allows user to retrieve contact list from a LDAP Server through LDAP protocols.

User must configure the LDAP Server information and Search Base to be able to use it on the device. If

the LDAP server requests an authentication, user should also provide username and password.

To configure a LDAP phonebook, the following information should be entered,

- Display Title (must)
- LDAP Server Address (must)
- LDAP Server Port (must)
- Search Base (must)
- Access username (optional)
- Access password (optional)

Web page preview

Phone page supports preview of Internet phone directory and contacts

- After setting up the XML Voip directory or LDAP,
- Select [**Phone book**] >> [**Cloud phone book**] >> [**Cloud phone book**] to select the type.
- Click the set XML/LDAP to download the contact for browsing.

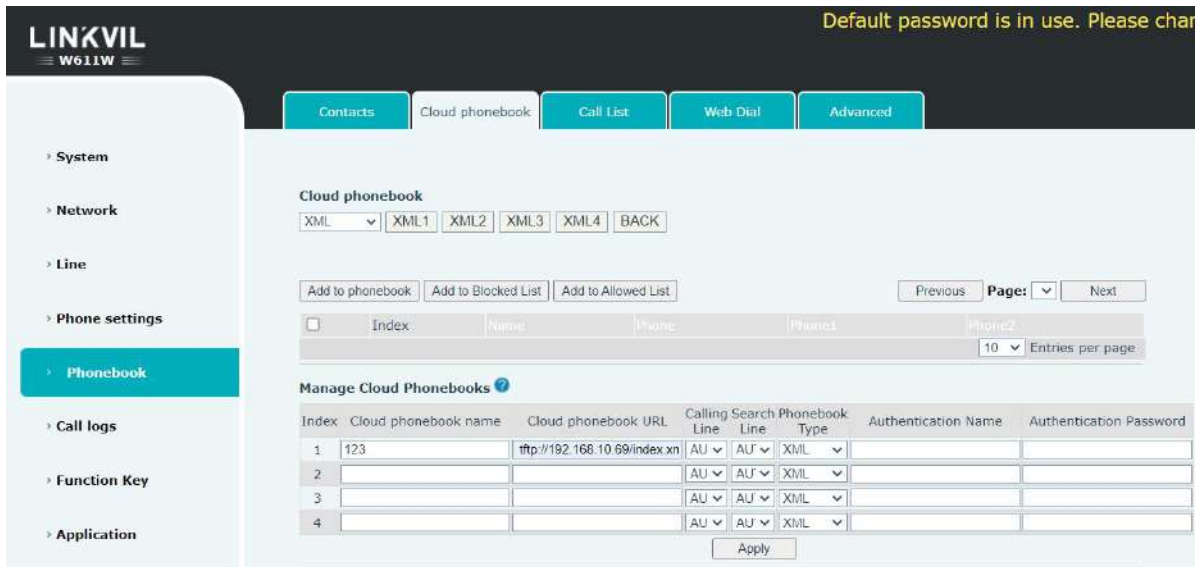

Picture 135 - Web cloud phone book Settings

12.21 Phonebook >> Call List

■ Restricted Incoming Calls:

It is similar like a Blocked List. Add the number to the Blocked List, and the user will no longer receive calls from the stored number until the user removes it from the list.

Users can add specific Numbers to the Blocked List or add specific prefixes to the Blocked List to block calls with all Numbers with this prefix.

■ Allowed Incoming Calls:

When DND is enabled, the incoming call number can still be called.

■ Restricted Outgoing Calls:

Adds a number that restricts outgoing calls and cannot be called until the number is removed from the

table.

12.22 Phonebook >> Web Dial

Use web pages for call, reply, and hang up operations.

12.23 Phonebook >> Advanced

Users can export the local phone book in XML, CSV, and VCF format and save it on the local computer. Users can also import contacts into the phone book in XML, CSV, and VCF formats.

Attention! If the user imports the same phone book repeatedly, the same contact will be ignored. If the name is the same but the number is different, the contact is created again.

Users can delete groups or add new groups on this page. Deleting a contact group does not delete contacts in that group.

12.24 Call Log

The user can browse the complete call record in this page. The call record can be sorted by time. Call number, contact name or line, and the call record can be screened by call record type (incoming call, outgoing call, missed call, forward call).

The user can also save the number in the call record to his/her phone book or add it to the Blocked List/whitelist.

Users can also dial the web page by clicking on the number in the call log.

12.25 Function Key >> Function Key

One-key transfer Settings: establish new call, blind transfer, attention-transfer, one-key three-way, Play DTMF.

The device provides multiple user-defined shortcut keys, and the user can configure each shortcut key on the web page.

Table 26 - Function Key configuration

Parameters	Description
Memory Key	<p>BLF (New Call/BXFE /AXFER): It is used to prompt user the state of the subscribe extension, and it can also pick up the subscribed number, which help user monitor the state of subscribe extension (idle, ringing, a call). There are 3 types for one-touch BLF transfer method.</p> <p>p.s. User should enter the pick-up number for specific BLF key to fulfill the pick-up operation.</p> <p>Presence: Compared to BLF, the Presence is also able to view whether the user is online.</p>

	<p>Note: You cannot subscribe the same number for BLF and Presence at the same time</p> <p>Speed Dial: You can call the number directly which you set. This feature is convenient for you to dial the number which you frequently dialed.</p> <p>Intercom: This feature allows the operator or the secretary to connect the phone quickly; it is widely used in office environments.</p>
Line	It can be configured as a Line Key. User is able to make a call by pressing Line Key.
Key Event	User can select a key event as a shortcut to trigger. For example: MWI / DND / Release / Headset / Hold / etc.
DTMF	It allows user to dial or edit dial number easily.
URL	Open the specific URL directly.
Multicast	Configure the multicast address and audio codec. User presses the key to initiate the multicast.
Action URL	The user can use a specific URL to make basic calls to the phone.
XML browser	Users can set the DSS Key for specific URL download and other operations.
PTT	Users can set PTT one button call to realize the function of pressing and holding the call and releasing the hang up.

12.26 Function Key >> DSSKey Page

Web Page Function Key >> Function Key, W611W can configure two page dsskey, 8 dsskey per page.

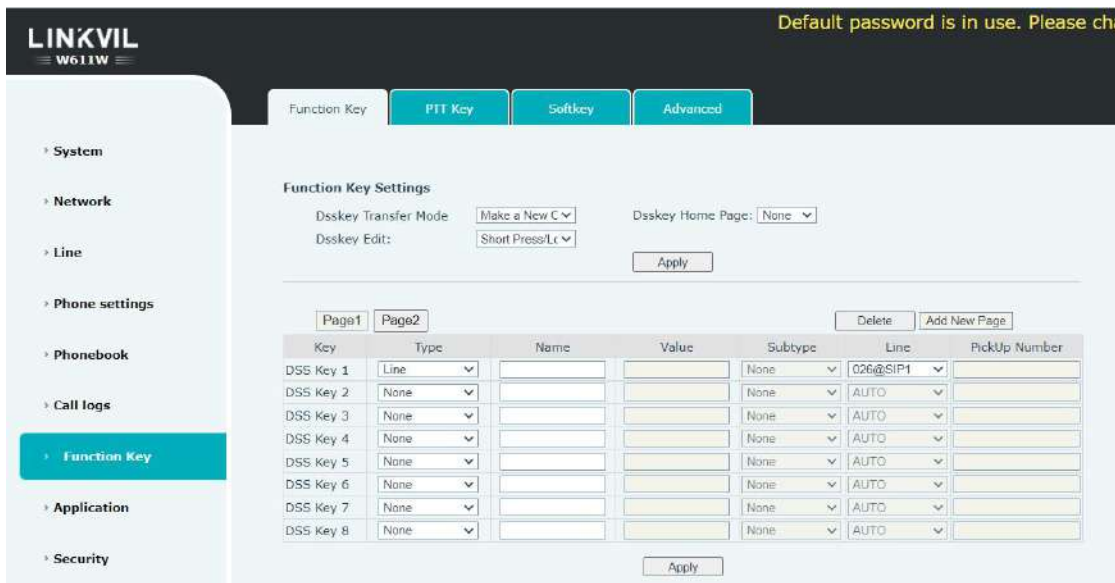

Picture 136 - DSSkey Page settings

After the DSS Key on page N is configured, set a softkey or navigation key to Dsskey PageN, press the softkey / navigation key in the corresponding interface, enter the Dsskey Page, select a DSS Key, or press

the corresponding serial number of the DSS Key to perform the corresponding functions.

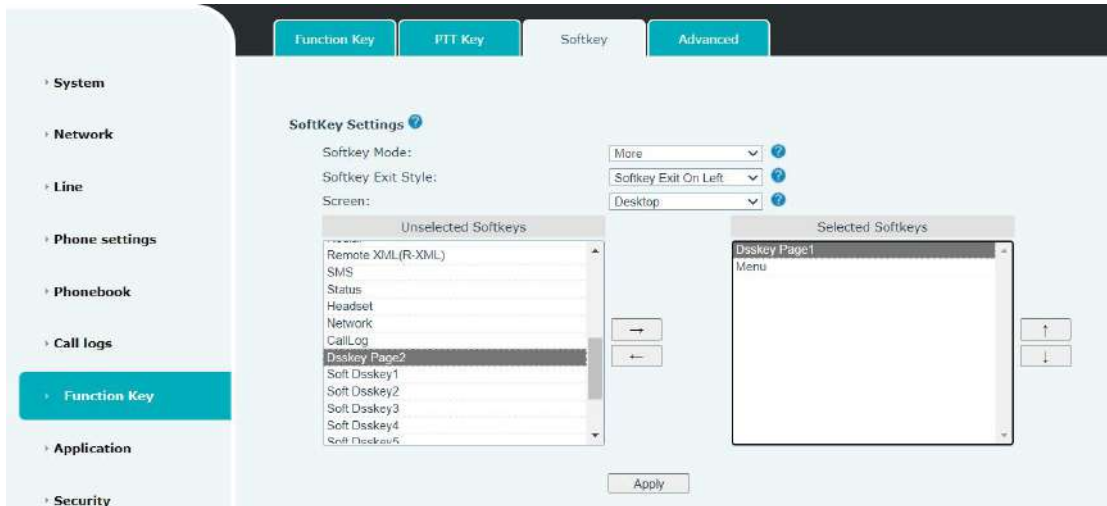

Picture 137 - The SoftKey is configured as a Dsskey Page

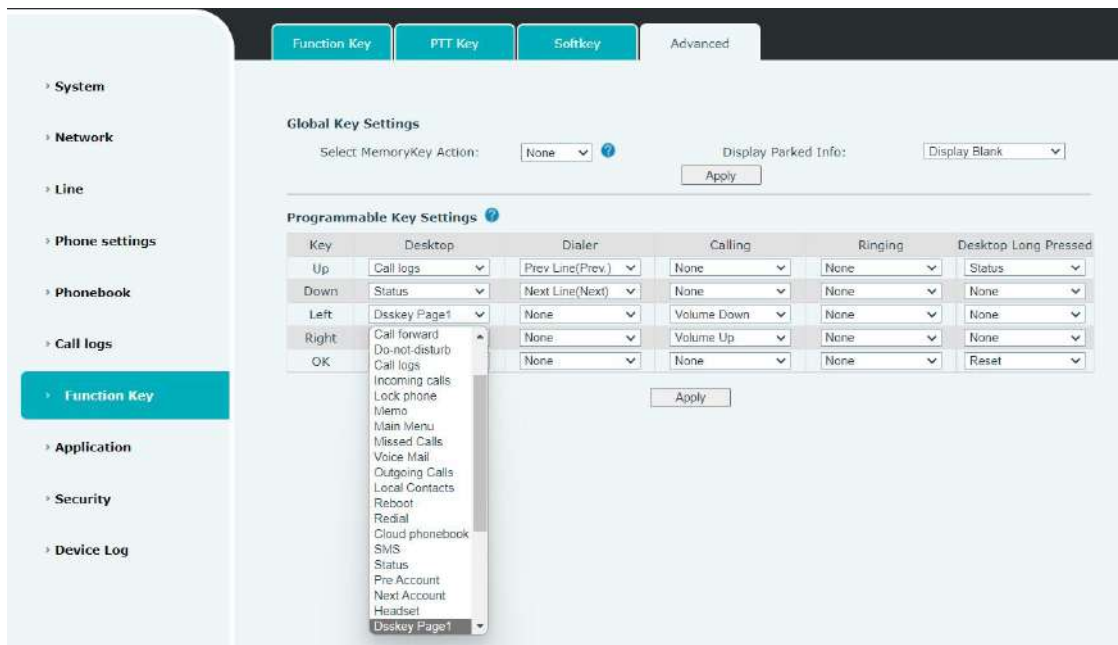

Picture 138 - The navigation key is configured as a Dsskey Page

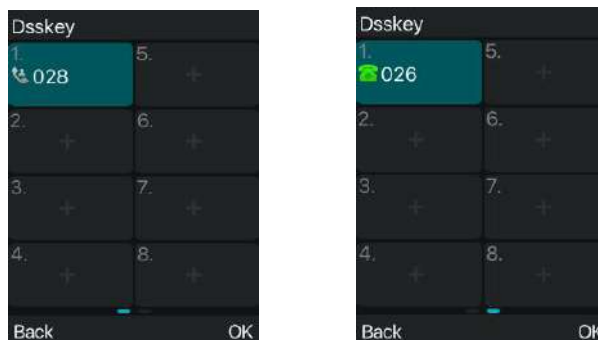

Picture 139 -The Dsskey Page on the lcd

12.27 Function Key >> PTT

PTT (Push To Talk) is the intercom function, press and hold the communication and end the communication.

Key	Type	Name	Value	Subtype	Line	PickUp Number
F 1	PTT		028	Speed Dial	026@SIP1	

Picture 140 -Web page PTT settings

Set the function key type to PTT, select the corresponding subtype (Speed Dial / Intercom / Multicast), and then set the number / multicast address. The use of methods are described as follows:

■ Speed Dial

Users can directly dial the set number, which facilitates customers to dial the number that they often need to call.

Key	Type	Name	Value	Subtype	Line	PickUp Number
F 1	PTT		028	Speed Dial	026@SIP1	

The position of the value fills in the number that requires speed dialing. After setting it, press and hold the function key while on standby, the device initiates a call, and the opposite end can answer the communication normally. Let go and end the call, and return to the standby interface.

Hold down the function key in the call, the device Hold original call, initiate the call, the opposite end answer can be normal communication. After letting go, end the call and return to the original call interface.

■ Intercom

The phone can automatically answer the intercom call.

Key	Type	Name	Value	Subtype	Line	PickUp Number
F 1	PTT		028	Intercom	026@SIP1	

The position of the value fills in the required number to be intercom, after setting, standby, press the function key not to put, the device initiates the intercom, the opposite end automatically answer, can be directly called. Let go and finish the intercom, and return to the standby interface.

Hold down the function key in the call, the device Hold original call, initiate the intercom, and answer the opposite end automatically. After letting go, finish the intercom and return to the original call interface.

■ MultiCast

Using the multicast function can easily and easily send voice broadcast to all members of the multicast group.

Key	Type	Name	Value	Subtype	Line	PickUp Number
F 1	PTT		239.1.1.1:1367	Multicast	G.711U	

The location of the value fills in the multicast address. After setting, press and hold the function key does not play, the device initiates the multicast, and all members in the multicast automatically answer, and can broadcast directly. After letting go, end the group broadcast and return to the standby interface.

Hold down the function key in the call, the device Hold original call, initiate the multicast, and all members in the multicast automatically answer. After letting go, end the group broadcast and return to the original call interface.

12.28 Function Key >> Softkey

The User Settings mode and display style, display page.

Table 27 - Softkey configuration

Parameter	Description
Softkey Mode	
Softkey mode	Disabled and More, Default is More
Softkey Style	
Softkey display style	Softkey Exit on Left or Right
Screen	
Call Dialer	Redial/2aB/Delete/Exit/Call Back/Dial/Join/MWI/Local Contacts/Pickup/Call Log/Missed/Clear/In/Dialed/Pause/ Next line/Prev line/Headset/Audio/Video/Remote XML/DSS Key
Conference	Hold/Split/End/Release/Mute/DSS Key/Headset
Desktop	Call Log/Menu/Local Contacts/DND/Prev Account/Next Account/Blocked List/Call Back/Call Forward/Locked/Memo/ Missed/MWI/Dialed/Reboot/Redial/Remote XML/SMS/ Headset/Status/DSS Key/In
Divert Dialed	Redial/2aB/Delete/Exit/Forward/Local Contacts/Call Log /Clear/Missed/Dialed/Headset/Video/Audio/Remote XML /DSS Key
Ending	Redial/End/Headset/Release/DSS Key
Predictive Dialer	Dial/2aB/Delete/Exit/Call Back/Local Contacts/Redial /Pickup/MWI/Join/Call Log/Release/Missed/Pause/Dialed/ Headset/Video/Audio/Remote XML/DSS Key/In/Next line /Prev line
Ringling	Answer/Forward/Reject/Mute/Release/Headset/Video/Audio/DSS key

Talking	Hold/Transfer/Conference/End/Mute/Release/New Call/ Local Contacts/Listen/Call Log/Next call/Prev call/ Private/Headset/Video/Audio/DSS Key
Transfer Alerting	End/Transfer/Headset/Release/DSS Key
Transfer Dialer	Redial/Delete/Exit/2aB/Dial/Local Contacts/Transfer/ Call Log/Clear/Missed/Dialed/Pause/Headset/Video/Audio/Remote XML/DSS Key
Trying	End/Release/Headset/DSS Key
Waiting	Hold/Transfer/Conference/End/Answer/Forward/Mute/Next call/New call/Prev call/Reject/Release/Headset/Listen/ Video/Audio/DSS Key

12.29 Function Key >> Advanced

One key transfer: for example, set the memory key 4370. Press the memory key when talking with 4374 to decide whether to call 4370 or transfer 4374 to 4370.

Select memory key function: for example, the phone set the memory key value to 4370. When 4370 calls, press this key to hold the call or hang up.

■ Global Key Settings



Picture 141 - Global Key Settings

■ Programmable key Settings

Please refer to the [Table 27 Softkey configuration](#)

12.30 Application >> Manage Recording

See [9.1 Record](#) for details of recording.

12.31 Security >> Web Filter

The user can set up a configuration management phone that allows only machines with a certain network segment IP access.

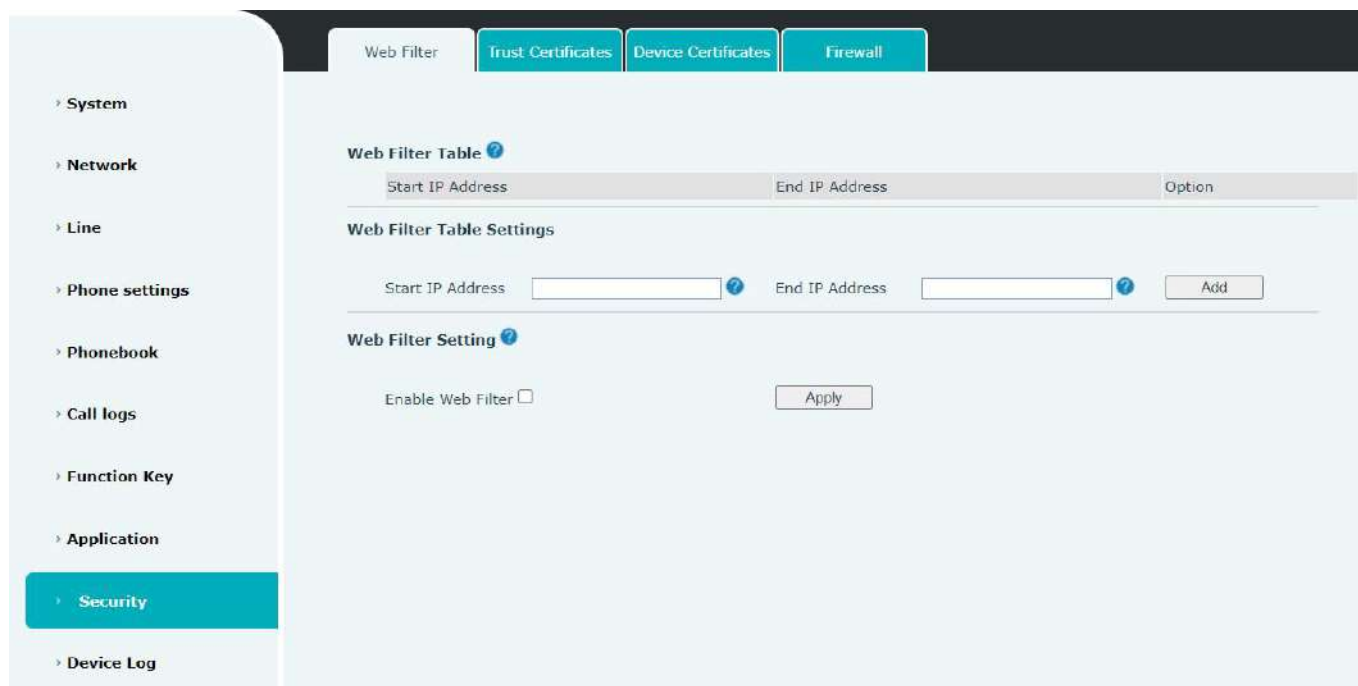

Picture 142 - Web Filter settings



Picture 143 - Web Filter Table

Adding and removing IP segments are accessible. Configure the starting IP address within the start IP, end the IP address within the end IP, and click **[Add]** to submit to take effect. A large network segment can be set, or it can be divided into several network segments to add. If the user wants to delete, select the initial IP of the network segment to be deleted from the drop-down menu, and then click **[Delete]** to take effect.

Enable web page filtering: configure enable/disable web page access filtering; Click the "apply" button to take effect.

Note: if the device you are accessing is in the same network segment as the phone, please do not configure the filter segment of the web page to be outside your own network segment, otherwise you will not be able to log in the web page.

12.32 Security >> Trust Certificates

Set whether to open license certificate and general name validation, select certificate module. You can upload and delete uploaded certificates.

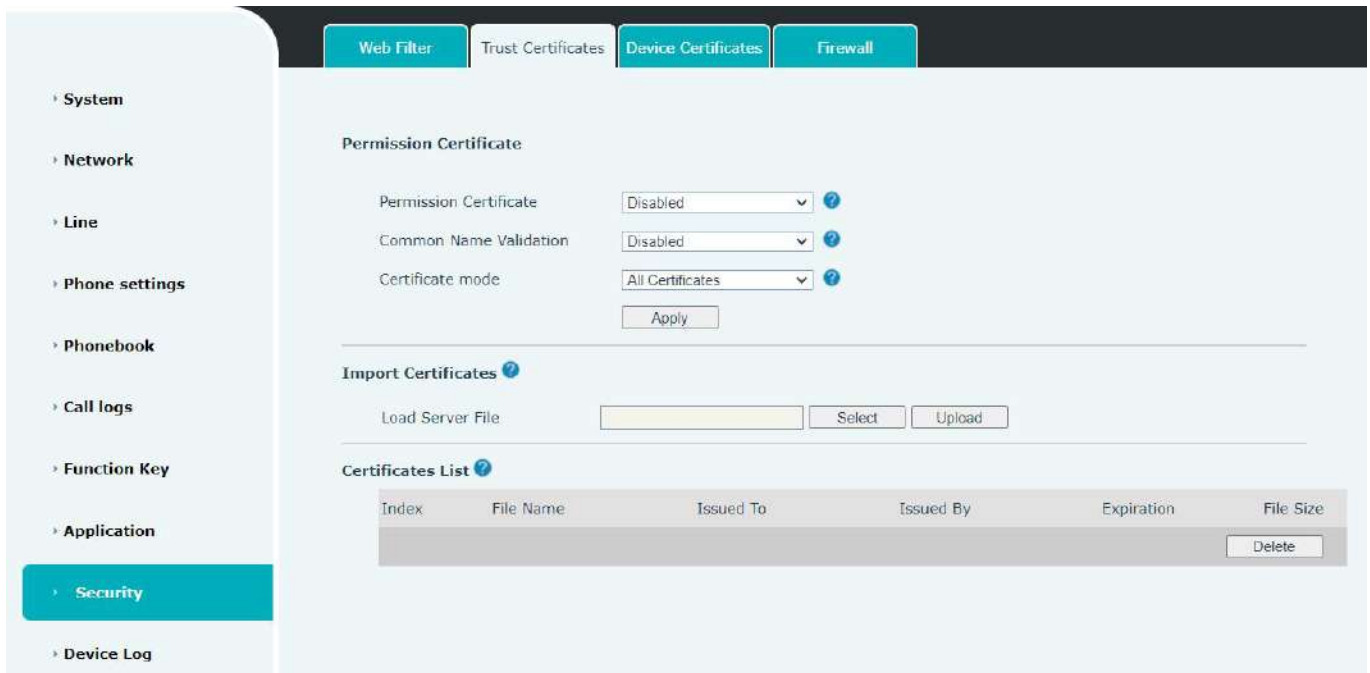

Picture 144 - Certificate of settings

12.33 Security >> Device Certificates

Select the device certificate as the default and custom certificate.
 You can upload and delete uploaded certificates.

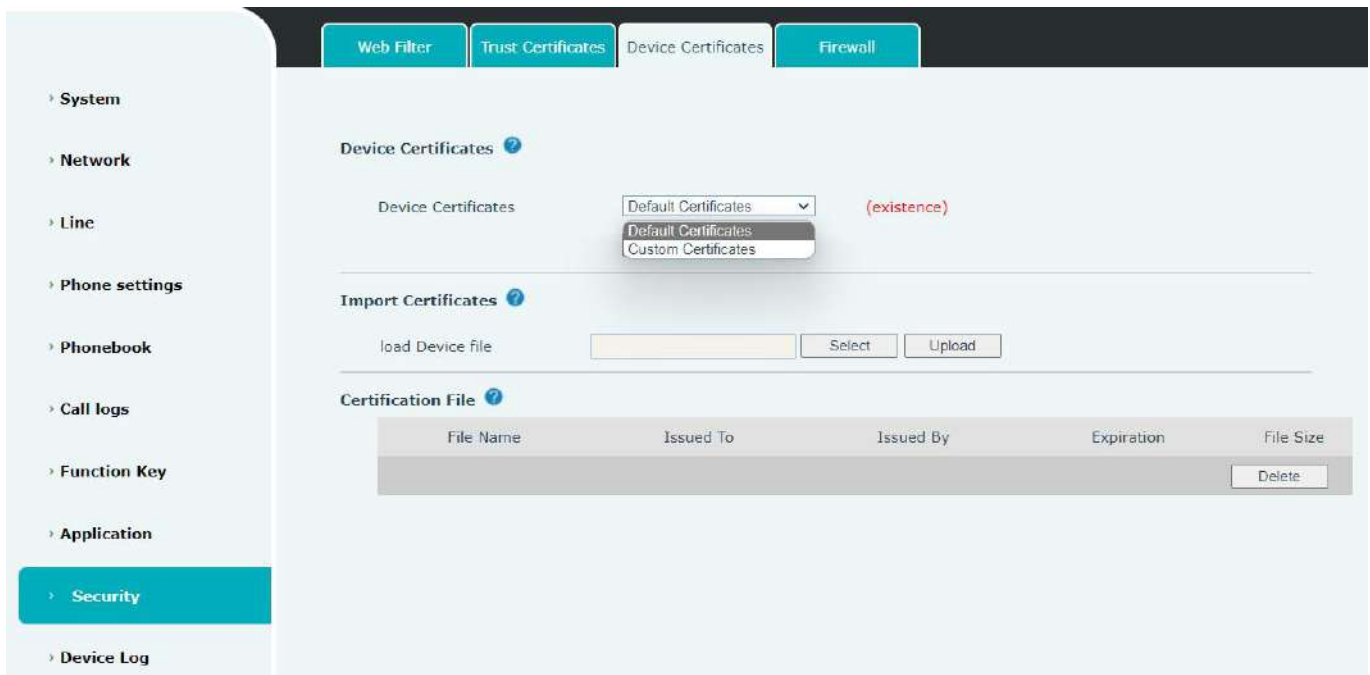

Picture 145 - Device certificate setting

12.34 Security >> Firewall

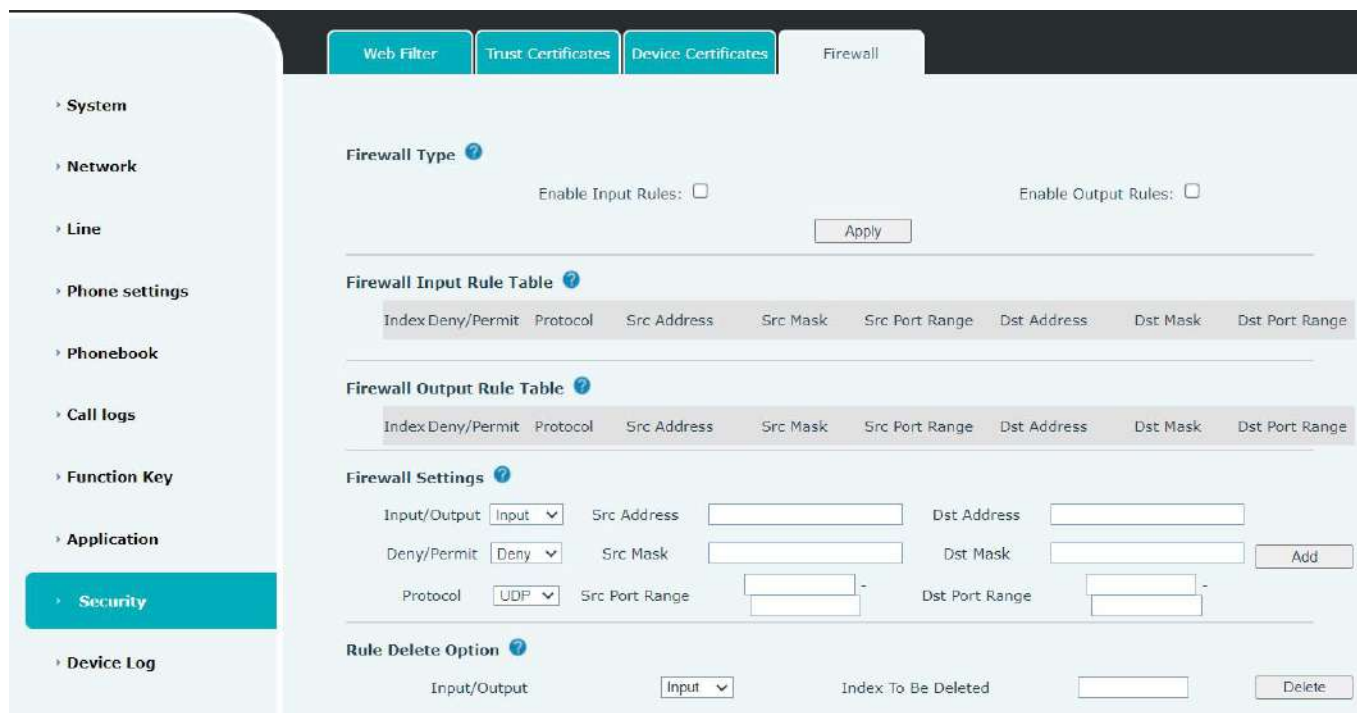

Picture 146 - Network firewall Settings

The user can set whether to enable the input through this page, output firewall and set the firewall input and output rules. Using these Settings can prevent some malicious network access, or restrict internal users access to some resources of the external network, which can improve security.

Firewall rule set is a simple firewall module. This feature supports two types of rules: input rules and output rules. Each rule is assigned an ordinal number, allowing up to 10 for each rule. Considering the complexity of firewall Settings, the following is an example to illustrate:

Table 28 - Network Firewall

Parameter	Description
Enable Input Rules	Indicates that the input rule application is enabled.
Enable Output Rules	Indicates that the output rule application is enabled.
Input/Output	To select whether the currently added rule is an input or output rule.
Deny/Permit	To select whether the current rule configuration is disabled or allowed;
Protocol	There are four types of filtering protocols: TCP UDP ICMP IP.
Src Port Range	Filter port range
Src Address	Source address can be host address, network address, or all addresses 0.0.0.0; It can also be a network address similar to *.*.*.0, such as: 192.168.1.0.
Dst Address	The destination address can be either the specific IP address or the full

	address 0.0.0.0; It can also be a network address similar to *.*.*.0, such as: 192.168.1.0.
Src Mask	Is the source address mask. When configured as 255.255.255.255, it means that the host is specific. When set as 255.255.255.0, it means that a network segment is filtered.
Dst Mask	Is the destination address mask. When configured as 255.255.255.255, it means the specific host. When set as 255.255.255.0, it means that a network segment is filtered.

After setting, click **[Add]** and a new item will be added in the firewall input rule, as shown in the figure below:

Index	Deny/Permit	Protocol	Src Address	Src Mask	Src Port Range	Dst Address	Dst Mask	Dst Port Range
1	deny	udp	192.168.1.0	192.168.1.154	0-9	255.255.255.0	255.255.255.0	0-9

Picture 147 - Firewall Input rule table

Then select and click the button **[Apply]**.

In this way, when the device is running: ping 192.168.1.118, the packet cannot be sent to 192.168.1.118 because the output rule is forbidden. However, the other IP of the ping 192.168.1.0 network segment can still receive the response packet from the destination host normally.

Rule Delete Option

Input/Output: Index To Be Deleted:

Picture 148 - Delete firewall rules

Select the list you want to delete and click **[Delete]** to delete the selected list.

12.35 Device Log >> Device Log

You can grab the device log, and when you encounter an abnormal problem, you can send the log to the technician to locate the problem. See [13.6 Get log information](#).

13 Trouble Shooting

When the phone is not in normal use, the user can try the following methods to restore normal operation of the phone or collect relevant information and send a problem report to Fanvil technical support mailbox.



13.1 Get Device System Information

Users can get information by pressing the **[Menu]** >> **[Status]** option in the phone. The following information will be provided:

The network information

Equipment information (model, software and hardware version), etc.

13.2 Power on/off

The user can press and hold the red hang up key  until it shuts down. Then press and hold the red hang up key  until it turns on.

13.3 Reboot Device

Users can reboot the device from soft-menu, **[Menu]** >> **[Basic]** >> **[Reboot System]**, and confirm the action by **[OK]**. Or, simply remove the power supply and restore it again.

13.4 Reset Device to Factory Default

Resetting Device to Factory Default will erase all the user's configuration, preference, database and profiles on the device and restore the device back to the state as factory default.

To perform a factory default reset, user should press **[Menu]** >> **[Advanced]**, and then input the password to enter the interface. Then choose **[Factory Reset]** and press **[Enter]**, and confirm the action by **[OK]**. The device will be rebooted into a clean factory default state.

13.5 Screenshot

If there is a problem with the phone, the screenshot can help the technician locate the function and identify the problem. In order to obtain screen shots, log in the phone webpage **[System]** >> **[Tools]**, and you can capture the pictures of the main screen and the secondary screen (you can capture them in the interface with problems).

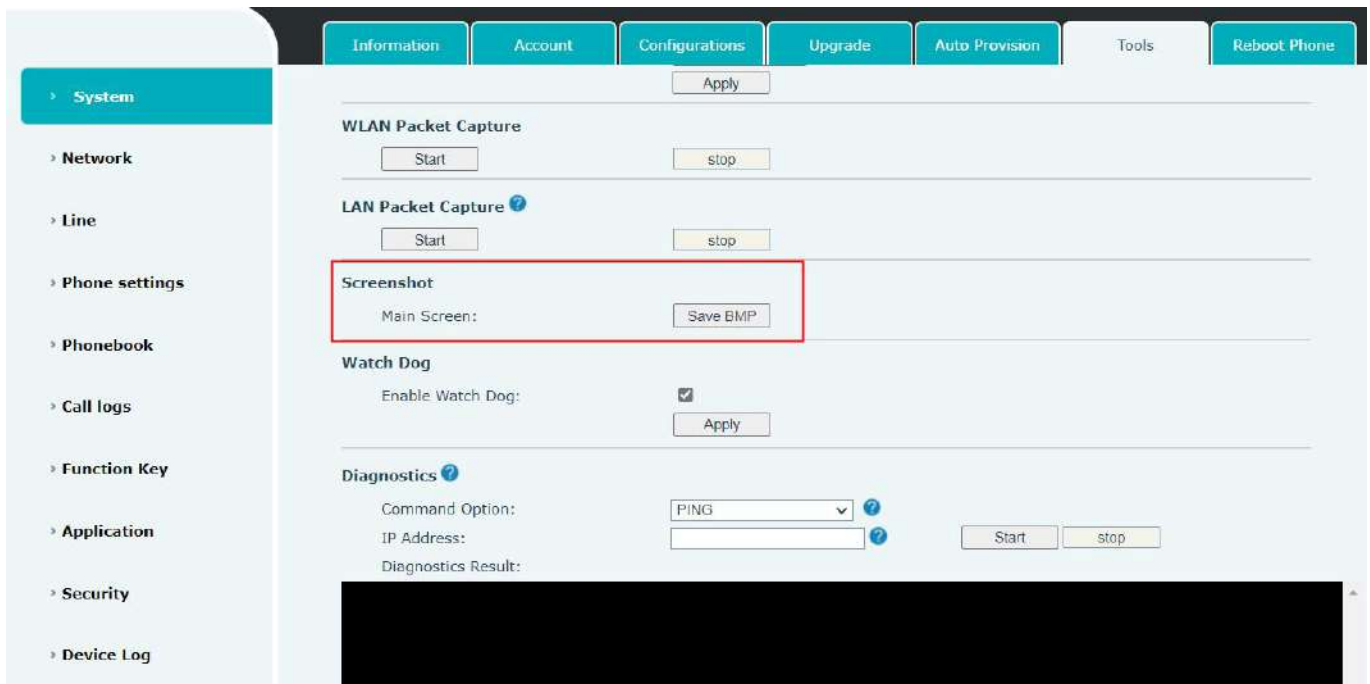

Picture 149 - Screenshot

13.6 Network Packets Capture

Sometimes it is helpful to dump the network packets of the device for issue identification. To get the packets dump of the device, user needs to log in the device web portal, open page **[System]** >> **[Tools]** and click **[Start]** in “Network Packets Capture” section. A pop-up message will be prompt to ask user to save the capture file. User then should perform the relevant operations such as activating/deactivating line or making phone calls and click **[Stop]** button in the web page when operation finished. The network packets of the device during the period have been dumped to the saved file.

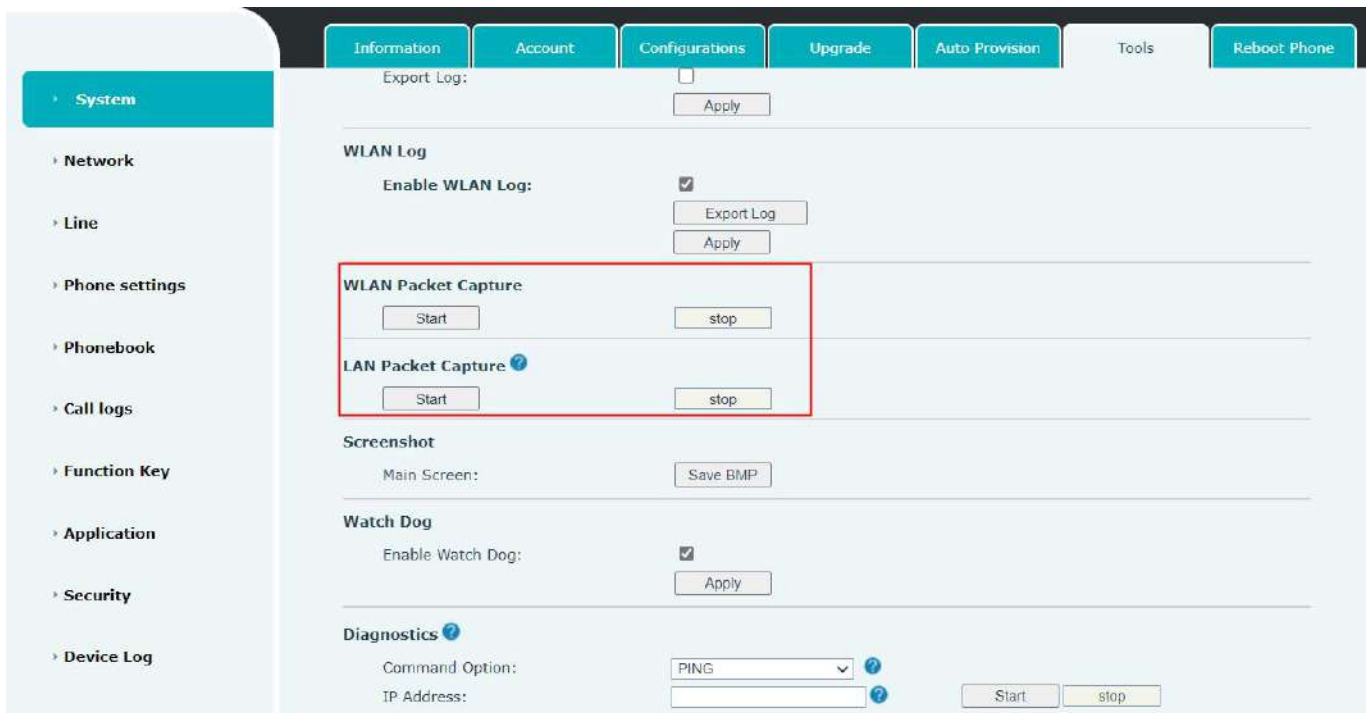

Picture 150 - Web capture

User may examine the packets with a packet analyzer or send it to Fanvil support mailbox.

13.7 Get Log Information

Log information is helpful when encountering an exception problem. In order to get the log information of the phone, the user can log in the phone web page, open the page [Device log], click the [Start] button, follow the steps of the problem until the problem appears, and then click the [End] button, [Save] to local analysis or send the log to the technician to locate the problem.

13.8 USB/U Disk Upgrade

13.8.1 USB Upgrade

- 1) Download the images compression package for the corresponding software version. Unpack the compressed file with the _images.tar.gz suffix, and copy all files in usbDownloadTools to the decompression image folder.
- 2) Get the device into download mode:
 - ① Keep the device turned off. Disconnect USB and press the red hang button to shut down. Note If the UBS is connected to the device, the device starts automatically after shutdown.
 - ② Press the "right button + hang up key" and release the usb. If successful in download mode, the device state should be in the black screen will not start.
 - ③ Open the Windows Device Manager and view the Universal Serial Bus Controller. If there is a USB Mass Storage Device, you are ready to download.

3) After completing the above preparation work, open the usb to download the software "USBDownloadTool 2.0.exe" and click "Upgrade Firmware" to start the upgrade. After the upgrade starts, the software becomes "unresponsive", which means it is under upgrade and takes about 1-2 minutes. When the upgrade completes, the software returns to normal and displays the following information.

```

10:07:46 reset [retry 3]
10:07:48 reset [retry 4]
10:07:49 reset [retry 5]
10:07:49 saveenv
10:07:51 saveenv [retry 1]
10:07:53 saveenv [retry 2]
10:07:54 saveenv [retry 3]
10:07:56 saveenv [retry 4]
10:07:57 saveenv [retry 5]
10:07:57 printenv
10:07:59 printenv [retry 1]
10:08:01 printenv [retry 2]
10:08:02 printenv [retry 3]
10:08:04 printenv [retry 4]
10:08:05 printenv [retry 5]
10:08:05 reset
10:08:07 reset [retry 1]
10:08:08 reset [retry 2]
10:08:10 reset [retry 3]
10:08:12 reset [retry 4]
10:08:13 reset [retry 5]
    
```

13.8.2 U Disk Upgrade

The U disk upgrade requires two upgrade files: sigmastarUpgrade.bin and upgrade_script.txt. Copy these two files to the U disk root directory. Note that the U disk format should be FAT32.

Because of the w611w, the device does not supply the power externally, so the usb hub is needed to connect the u-disk to the w611w phone. And the Usb hub interface should be Type-C.

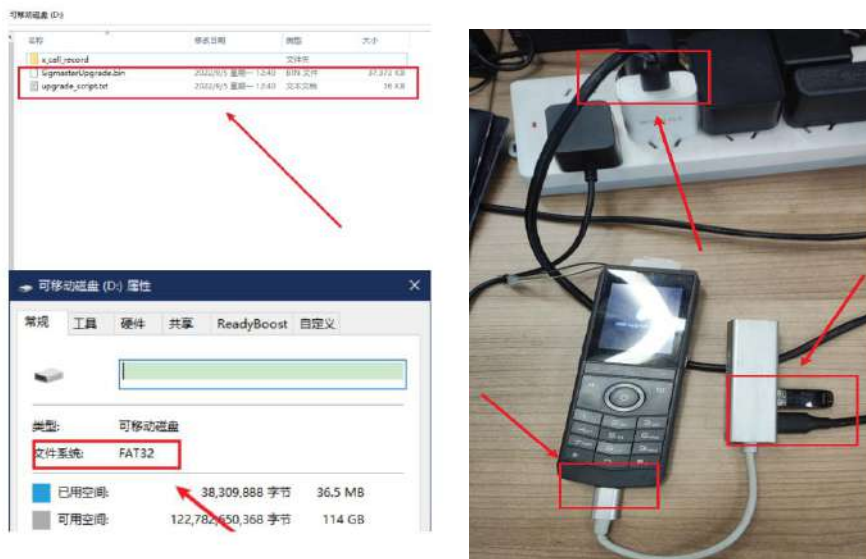

Picture 151 - reparation required for the U disk upgrade

Enter the upgrade mode step:



- 1) Keep the device turned off. Disconnect USB and press the red hang button to shut down. Note that if the UBS is connected to the device, the device starts automatically after shutdown.
- 2) Press the volume button and press the usb for about three seconds to release.

3)Success enters the upgrade mode, and the device displays the upgrade logo. At this time, the device will automatically select the upgrade file in the U disk, and upgrade after finding, the device will automatically restart after completion.

Note! If you mistakenly trigger the download mode, or enter the download mode to exit, you can long press the red hang up button to restart.

13.9 Common Trouble Cases

Table 29 - Trouble Cases

Trouble Case	Solution
Device could not boot up	<ol style="list-style-type: none"> 1. First consider the situation that the battery has been exhausted, and charge the device. Please use the charger configured at the time of purchase when charging. 2. If you see the phone enter "POST mode", it means that the phone system is damaged. Please contact technical support to help you restore the phone system.
Device could not register to a service provider	<ol style="list-style-type: none"> 1. Please check whether the phone is connected to the network. The phone needs to be connected to a wireless network, and check whether the wireless icon is normal. If the icon shows  or , the network is unavailable, please check the network facilities. 2. Please check whether the phone has an IP address. Check the system information. If the IP address is Negotiating..., it means that the phone has not obtained an IP address. Please check whether the network configuration is correct. 3. If the network connection is good, please check your line configuration again. If all configurations are correct, please contact your service provider for support, or follow the instructions in "13.5 Network Packet Capture" to obtain a registered network packet and send it to the manufacturer's support mailbox to help analyze the problem.
No Audio or Poor Audio in Handset	<ol style="list-style-type: none"> 1. Please check whether the headset is connected, the headset icon  is displayed in the upper right corner. After connecting the headset, the earpiece channel cannot be used; after unplugging the headset, the earpiece channel can be used. 2. At this point the network bandwidth and latency may not be suitable for audio calls.
Poor Audio or Low Volume in Headset	<ol style="list-style-type: none"> 1. Please use the Headset provided by manufacturer. 2. The network bandwidth and delay may be not suitable for audio call at the moment.

<p>Audio is chopping at far-end in Hands-free speaker mode</p>	<p>This is usually due to loud volume feedback from speaker to microphone. Please lower down the speaker volume a little bit, the phenomenon will be gone.</p>
--	--